

### IMPORTANT:

Manufacturer is not responsible for negligent use of vehicle with mud flaps installed, including over-tightening of screws and bolts causing damage to vehicle or mud flaps.

### TOOLS REQUIRED-

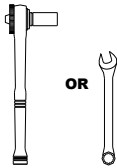

OR

7mm Open Wrench or  
Socket Wrench

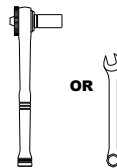

OR

1/4" Open Wrench or  
Socket Wrench

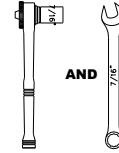

AND

7/16" Open Wrench and  
Socket Wrench



Push Pin  
Removal Tool

### FLAPS & BRACKETS

(1) Upper Mount,  
Front, DS

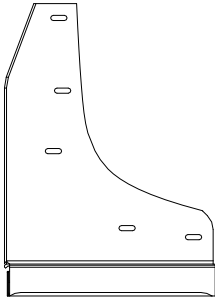

Please note:  
There will be a  
plastic piece in  
the upper mount  
channel. Please  
remove and  
discard.

(1) Upper Mount  
Front, PS

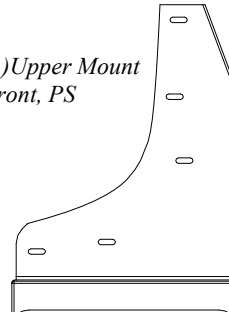

(2) Rubber Flap  
Universal  
12" x 8-3/4"

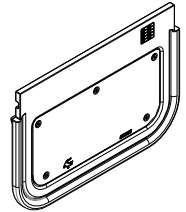

(2) Washer Plate  
Front,  
Part #759979

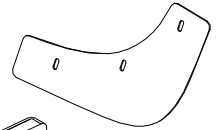

Brace, DS  
Front  
Part #759973

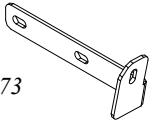

Brace, PS  
Front  
Part #759974

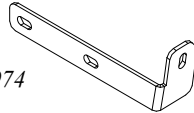

(1) Nylon Cap  
Driver Side  
Part #080642  
Assembled on Upper Mount

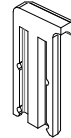

(1) Nylon Cap  
Passenger Side  
Part #080643  
Assembled on Upper Mount

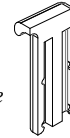

### PARTS BAG # 770512

**a)** (4) Cap Screw, SS Blk Ox.  
1/4-20UNC x 3/8"  
Part #014069



**b)** (2) Cap Screw, SS Blk Ox.  
1/4-20UNC x 1.5"  
Part #014074



**c)** (4) Sheet Mtl Screw  
#8-18 x 1.5" SS Blk. Ox.  
Part #016063



**d)** (2) Washer, Flat  
0.281" x 1" SS  
Part #018068

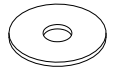

**e)** (6) Washer, Flat  
0.281" x 1" SS Blk Ox.  
Part #018069

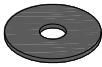

**f)** (4) Washer, Flat  
0.203" x 1" SS Blk Ox.  
Part #018070



**g)** (2) Washer, Lock  
1/4" Helicoil, SS  
Part #024000



**h)** (2) Nut, Hex  
1/4-20, SS  
Part # 025000



**i)** (4) Serrated Flange Nut  
M6 - 1, Plated  
Part # 025025



**j)** (4) Spring Nut, SS  
1/4"-20UNC, 27/32" Reach  
Part #028011



**k)** (2) Washer, White Nylon  
0.318" x 1" x 0.04"  
Part #054061  
(Running change - Black or White)



**l)** (4) Washer, Black Nylon  
0.203" x 0.885" x 0.062"  
Part #054080



**m)** (4) Spacer Washer, HDPE  
7/16" x 1" x 1/4"  
Part #054091



## ASSEMBLY OF NYLON MUD FLAPS:

1. Remove locking caps from nylon upper mounts and set aside for reinstallation.
2. Remove and discard the plastic strip inside the track at the bottom of the nylon upper mount.
3. Slide rubber guide into track of nylon upper mount.
4. Reinstall locking cap(s) on bottom of nylon upper mount. Note: To fully lock this cap into place, you should hear two clicks. When the cap is fully locked, it will be even with the offset part of the upper mount.
5. Repeat Procedure for second mud flap.

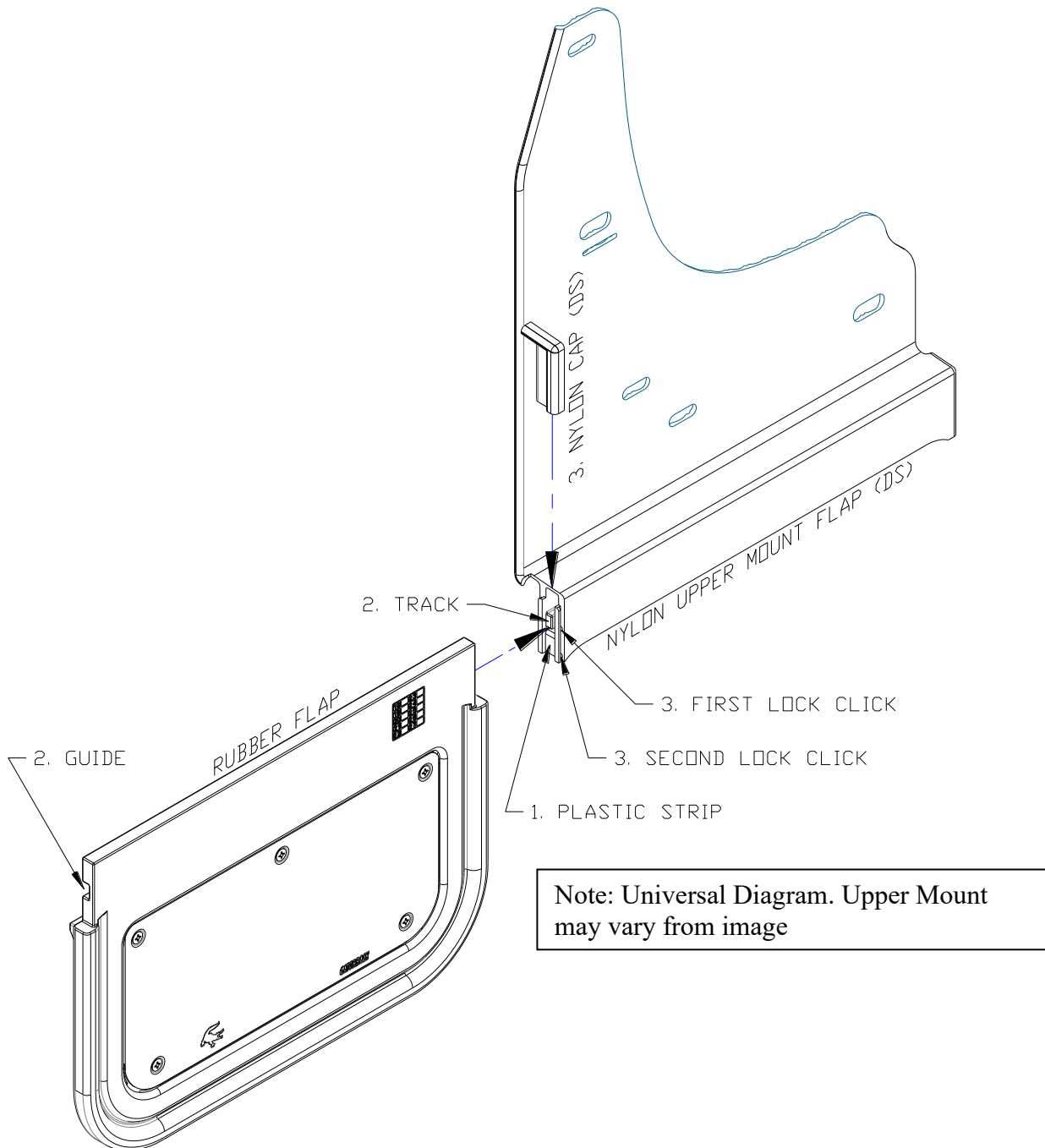

Please check out our YouTube channel to see an install video for this application



## INSTALLATION *(For ease of installation it is suggested that the wheel be removed)*

1. Before you install your Mud Flap Set, see the diagram and parts list for all necessary parts.
2. Place mud flap holes #3 and #4 over factory screws, and mark flare through mud flap holes #1 & #2 to indicate placement of spring nuts (j). Remove mud flap.
2. Install spring nuts (j) on flare over marks made in step 2.
3. Remove the (2) factory screws from factory holes #8 & #9 on the inside of the fender.
4. Loosely install brace holes #11 and #12 to the existing factory lower fender bolts using serrated flange nuts (i).
5. Loosely secure washer plate hole #6 through mud flap hole #3 to factory hole #8, and mud washer plate hole #7 through mud flap hole #4 to factory hole #9 using sheet metal screw (c), flat washer (f), and nylon washer (l).
6. Loosely secure mud flap holes #1 & #2 to spring nuts (j) using cap screw (a), flat washer (e), and spacer washer (m).
7. Loosely install mud flap hole #5 to bracket hole #10 using cap screw (b) and flat washer (e) and secure using a nylon washer (k), flat washer (d), lock washer (g), and hex nut (h).
8. Using a square or other leveling tool, ensure mud flap is level and tighten all fasteners.
9. Repeat procedure on the passenger side.

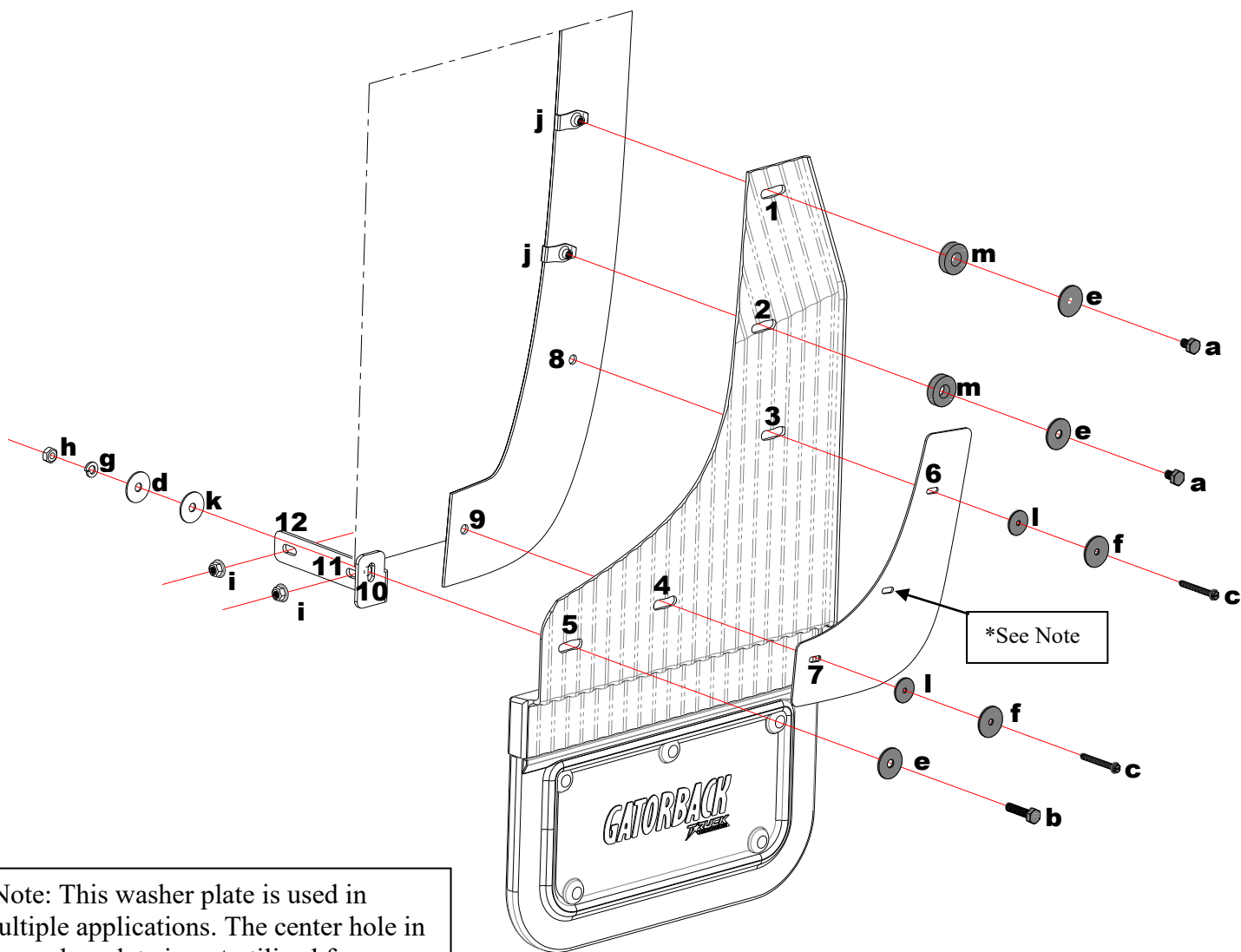

\*Note: This washer plate is used in multiple applications. The center hole in the washer plate is **not** utilized for installation of the GCN410F Mud Flap

Please check out our YouTube channel to see an install video for this application.



**IMPORTANT:**

**Manufacturer is not responsible for negligent use of vehicle with mud flaps installed, including over-tightening of screws and bolts causing damage to vehicle or mud flaps.**

**TOOLS REQUIRED-**

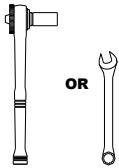

OR

7mm Open Wrench or  
Socket Wrench

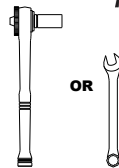

OR

1/4" Open Wrench or  
Socket Wrench

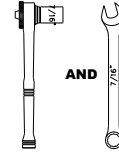

AND

7/16" Open Wrench and  
Socket Wrench



Push Pin  
Removal Tool

**FLAPS & BRACKETS**

(1) Flap Assembly,  
Rear, DS

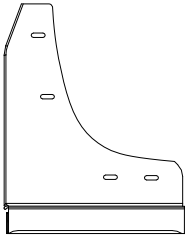

(1) Flap Assembly  
Rear, PS

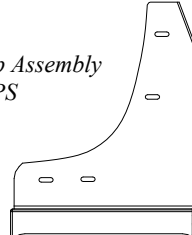

Please note:  
There will be  
a plastic piece  
in the upper  
mount  
channel.  
Please remove  
and discard.

(1) Washer Plate  
Rear, DS  
Part #770510

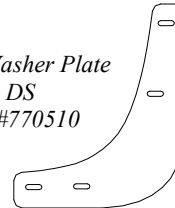

(1) Washer Plate  
Rear, PS  
Part #770511

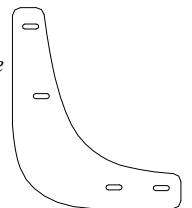

(2) Rubber Flap  
Universal  
12" x 8-3/4"

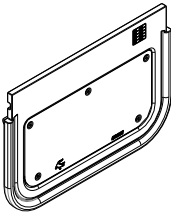

(1) Brace, DS  
Rear  
Part #759977

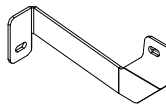

Brace, PS  
Rear  
Part #759978

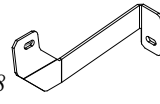

(1) Nylon Cap  
Driver Side  
Part #080642

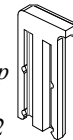

(1) Nylon Cap  
Passenger Side  
Part #080643

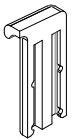

(Caps are Assembled on Upper Mount)

**PARTS BAG # 770513**

a) (2) Cap Screw, SS Blk Ox.  
1/4-20UNC x 3/8"  
Part #014069



b) (4) Cap Screw, SS Blk Ox.  
1/4-20UNC x 1"  
Part #014073



c) (4) Sheet Mtl Screw  
#8-18 x 1.5" SS Blk. Ox.  
Part #016055



d) (4) Washer, Flat  
0.281" x 1" SS  
Part #018068



e) (6) Washer, Flat  
0.281" x 1" SS Blk Ox.  
Part #018069



f) (4) Washer, Flat  
0.203" x 1" SS Blk Ox.  
Part #018070



g) (4) Washer, Lock  
1/4" Helicoil, SS  
Part #024000



h) (4) Nut, Hex  
1/4-20, SS  
Part # 025000



i) (2) Spring Nut, SS  
#8, 9/16" Reach  
Part # 028004



j) (2) Spring Nut, SS  
1/4"-20UNC, 27/32" Reach  
Part #028011



k) (12) Washer, Nylon  
0.318" x 1" x 0.04"  
Part #054061  
(Running change - Black or White)



## ASSEMBLY OF NYLON MUD FLAPS:

1. Remove locking caps from nylon upper mounts and set aside for reinstallation.
2. Remove and discard the plastic strip inside the track at the bottom of the nylon upper mount.
3. Slide rubber guide into track of nylon upper mount.
4. Reinstall locking cap(s) on bottom of nylon upper mount. Note: To fully lock this cap into place, you should hear two clicks. When the cap is fully locked, it will be even with the offset part of the upper mount.
5. Repeat Procedure for second mud flap.

Note: Universal Diagram. Upper Mount may vary from image

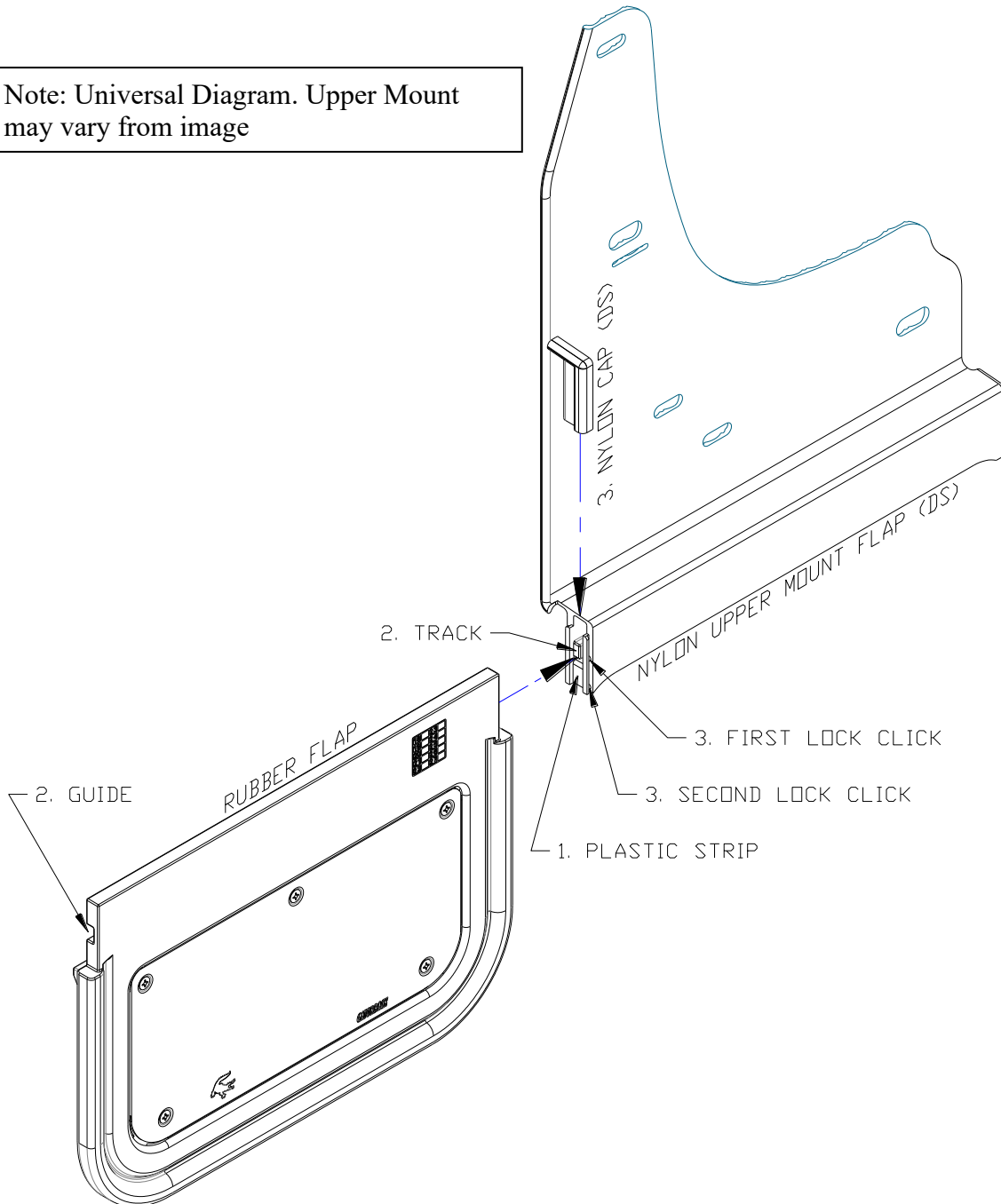

## INSTALLATION *(For ease of installation it is suggested that the wheel be removed)*

3. Before you install your Mud Flap Set, see the diagram and parts list for all necessary parts.
2. Remove the (2) factory screws on the inside of the fender flare. On the inner most factory hole, also remove the factory plastic nutsert
3. Install spring nut (i) on factory hole #10 on fender where nutsert was removed.
4. Remove the factory push pin closest to the wheel well from the underside of the fender.
5. Loosely install brace hole #12 to the factory hole on the underside of the fender using a cap screw (b), and flat washer (e), and secure using a nylon washer (k), flat washer (d), lock washer (g) and hex nut (h).
6. Loosely secure washer plate hole #7 through mud flap hole #3 to spring nut (i) on factory hole #10 using sheet metal screw (c), flat washer (f), and nylon washer (k).
7. Mark the fender through mud flap hole #1.
8. Install spring nut (j) over mark on fender made in step 8.
9. Loosely secure washer plate hole #6 through mud flap hole #2 to factory hole #9 using sheet metal screw (c), flat washer (f), and nylon washer (k).
10. Reinstall hardware on mud flap hole #2.
11. Loosely install backing plate hole #5 through mud flap hole #1 to spring nut (j) using cap screw (a), flat washer (e), and nylon washer (k).
12. Install washer plate hole #8 through mud flap hole #4 to bracket hole #11 using cap screw (b), flat washer (e), and nylon washer (k), and secure using a nylon washer (k), flat washer (d), lock washer (g) and hex nut (h).
13. Using a square or other leveling tool, ensure mud flap is level and tighten all fasteners.
14. Repeat procedure on the passenger side.

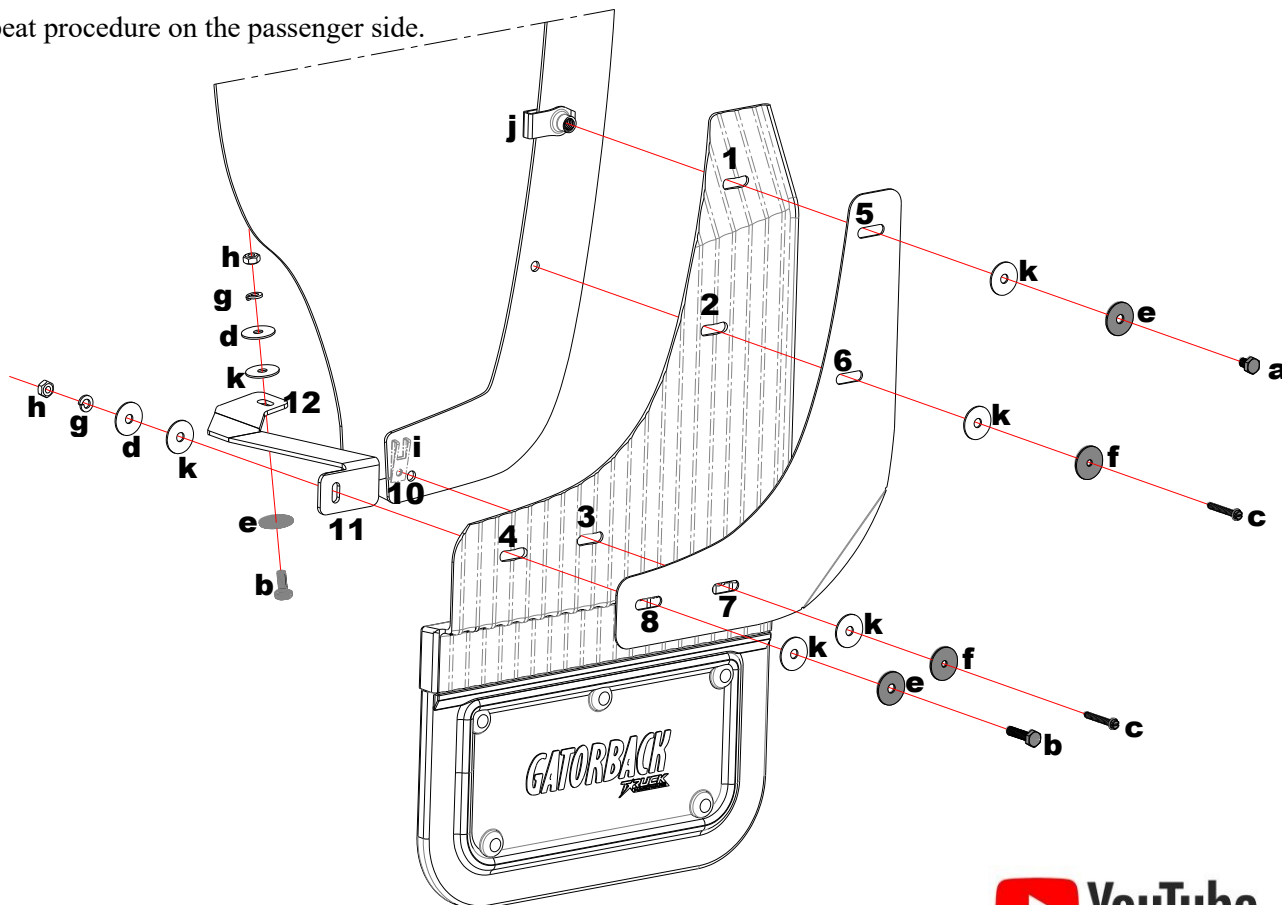

Please check out our YouTube channel to see an install video for this application

