



19-20 GMC Sierra 1500
Nylon Mud Flap Set, 5/8" Offset, Front
Mounting Diagram & Instructions
Kit# GCN29F

TO BE USED WITH SIERRA CAP PART #FC001K

IMPORTANT:

Manufacturer is not responsible for negligent use of vehicle with mud flaps installed, including over-tightening of screws and bolts causing damage to vehicle or mud flaps.



TOOLS REQUIRED-

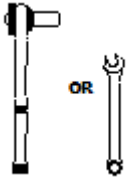

7/16" Open Wrench or
Socket Wrench



1/4" Socket Driver



T15 Torx
Bit

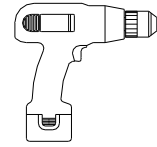

Electric or Rechargeable
Drill

FLAPS

(1) Flap Assy Upper
Rear, DS
Part #768349

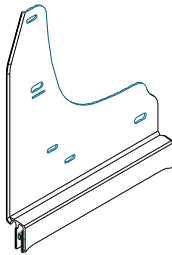

(1) Flap Assy Upper
Rear, PS
Part #768350

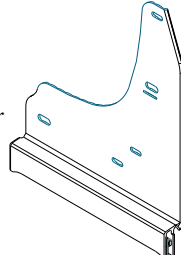

(2) Rubber Flap
Universal
12" x 8-3/4"

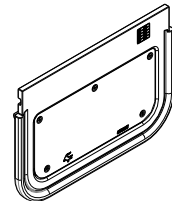

(1) Nylon Cap
Driver Side
Part #080642

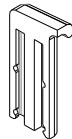

(1) Nylon Cap
Passenger Side
Part #080643

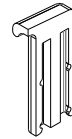

PARTS BAG # 76777

a) (4) Washer, Flat
0.281" x 1", 18g, SS, oxid.
Part #018069

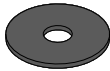

b) (6) Washer, Flat
0.203" x 1", 18g, SS, oxid.
Part #018070

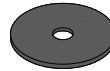

c) (4) Cap Screw, Black Ox
1/4"-20UNC x 5/8"
Part #014071



d) (6) Screw, Sheet Metal, Blk Ox.
1/4" Hex Washer Head, #8-18x1"
Part #016055



e) (1) Mud Flap Clip
Driver Side
Part #769312

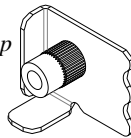

f) (1) Mud Flap Clip
Passenger Side
Part #769313

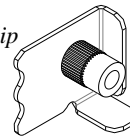

g) (2) Spring Nut
1/4"-20UNC, 27/32" Reach
Part #028006

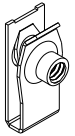

SOLD SEPARATELY: FC001K FINISHING CAPS

(1) Molded Cap
Driver's Side

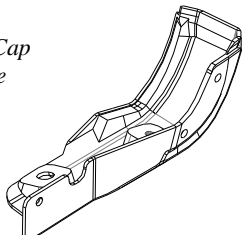

(1) Molded Cap
Passenger's Side

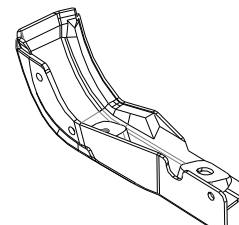

INSTALLATION - Start with installation of Truck Hardware Finishing Cap

(For ease of installation it is suggested that the wheel be removed)

CAPS:

1. Remove the 4 factory screws from the existing factory guard. Set this hardware aside for later reinstallation.
2. Because there is no external access to the interior push pin like on the rear guard, the front guard must be pulled off by hand.
3. Slightly peel back the red 3M tape on the finishing cap and fold back so it can be fully peeled after cap is in place.
4. Position cap, ensuring the top lip of the cap slides under the fender molding as shown.
5. If installing Gatorback Mud Flaps, reinstall the two factory screws on the underside of the finishing cap. If no flaps are being installed, reinstall the four factory screws to secure the cap. Be careful not to overtighten.
6. Finish peeling 3M tape and press firmly on the bottom and side of the finishing cap to ensure a proper seal.
7. Repeat procedure on passenger side.

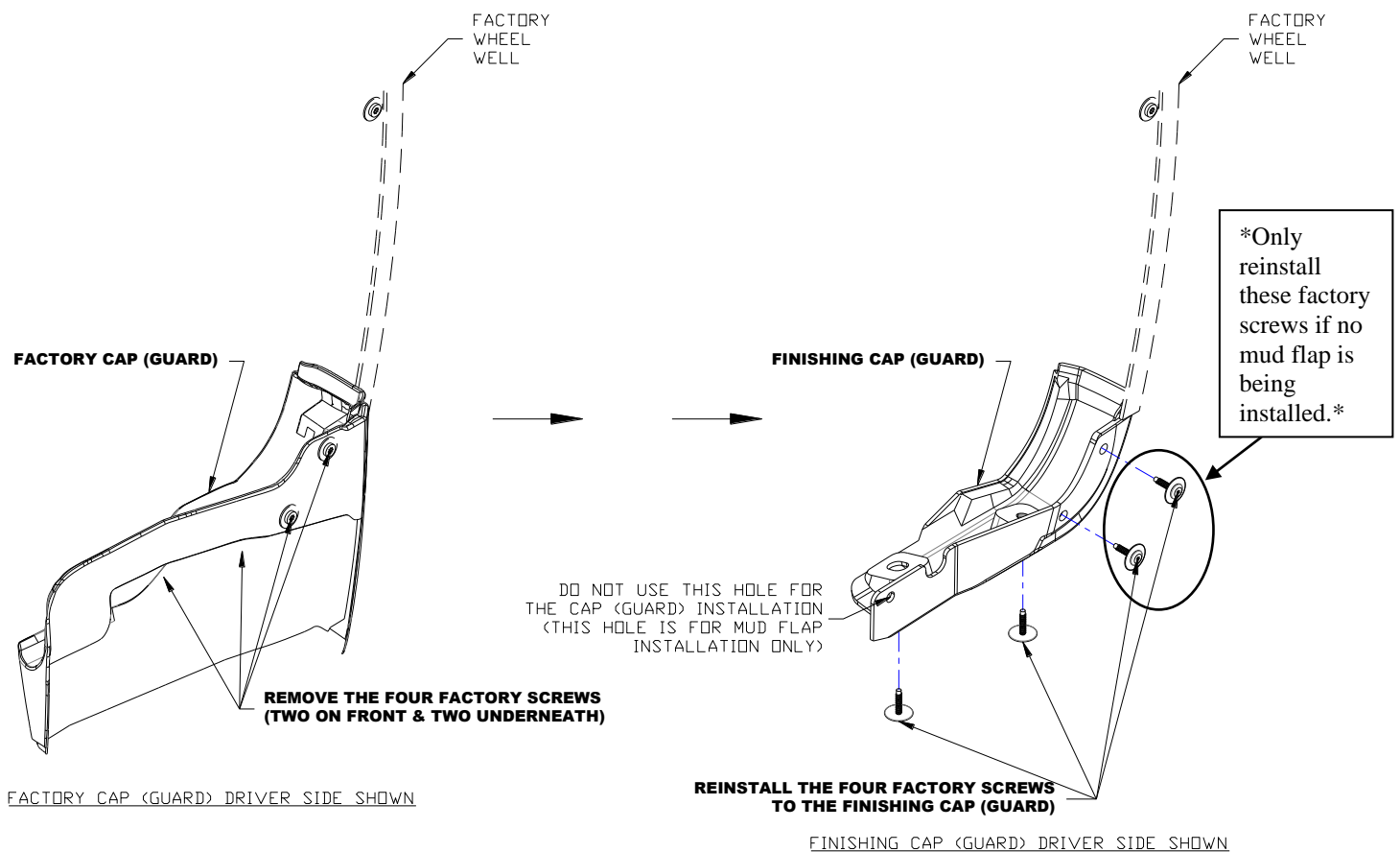

Please check out our YouTube channel to see an install video for this application.



Sierra Front

ASSEMBLY OF NYLON MUD FLAPS:

1. Remove and discard the plastic strip inside the track at the bottom of the nylon upper mount. (See Diagram #1).
2. Slide rubber guide into track of nylon upper mount.
3. Install included cap(s) on bottom of nylon upper mount. To fully lock this cap into place, you should hear two clicks, and cap will be even with the offset part of the upper mount. (See Diagram #1).
4. Repeat Procedure for second mud flap.

MUD FLAPS:

1. Before you install your Mud Flap Set, see the diagram and parts list for all necessary parts. Start on the driver's side.
2. Remove factory screw from wheel well hole #6. *Note* Factory screws on holes #7 & #8 will have been removed during cap installation.
3. Install spring nut (g) on plastic cap hole #9.
4. Loosely install mount clip (e) on mud flap hole #2 using a cap screw (c) and flat washer (a).
5. Secure mud flap through hole #5 into spring nut on plastic cap hole #9 using supplied cap screw (c) and washer (a).
6. Install mount clip (e) in hole #2 behind the fender lip.
7. Secure mud flap through hole #1 into hole #6 using supplied screw (d) and washer (b).
8. Secure the mud flap through hole #3 and #4 into holes #7 & #8 using supplied screws (d) and washers (b). Loosely secure at this point.
9. Align the top of the mud flap with the beveled edge of the factory flare. Tighten fastener on hole #1.
10. Using a bubble level or other levelling tool, ensure that the mud flap is level. Tighten fasteners.
11. Repeat procedure for passenger side.

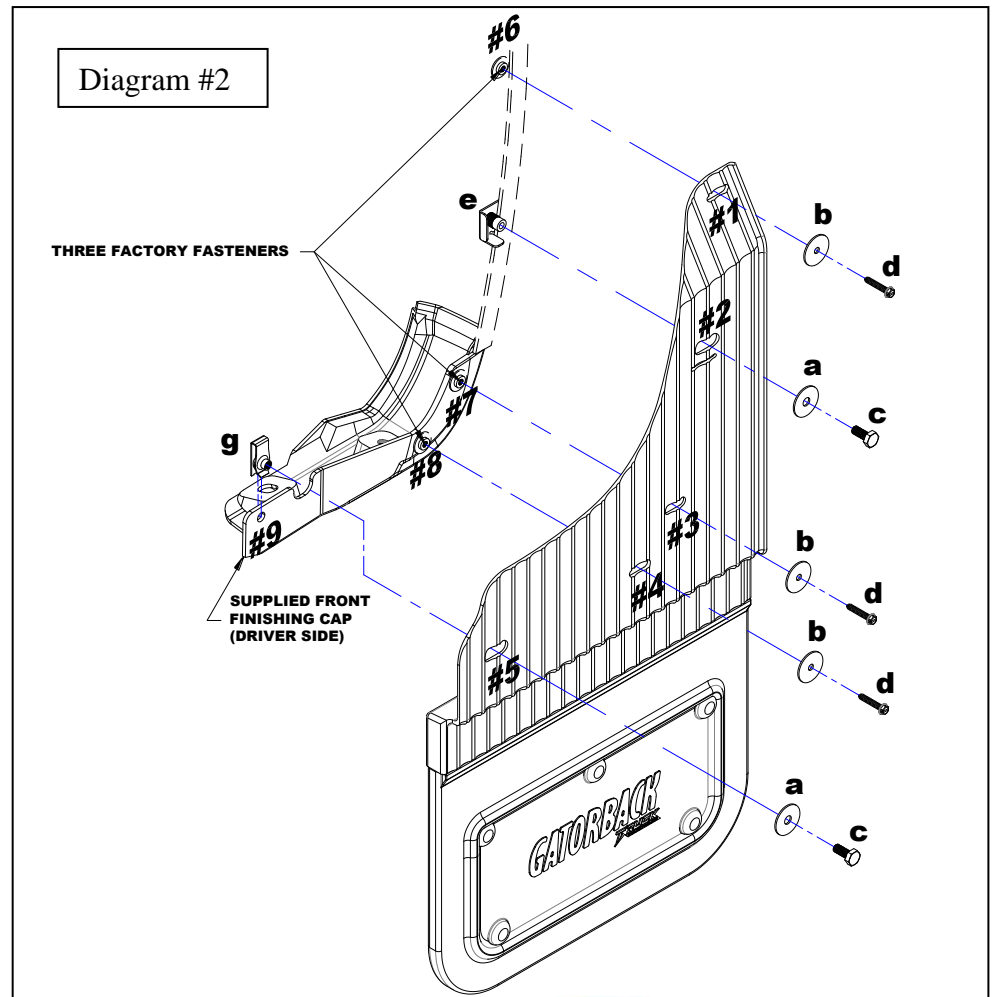
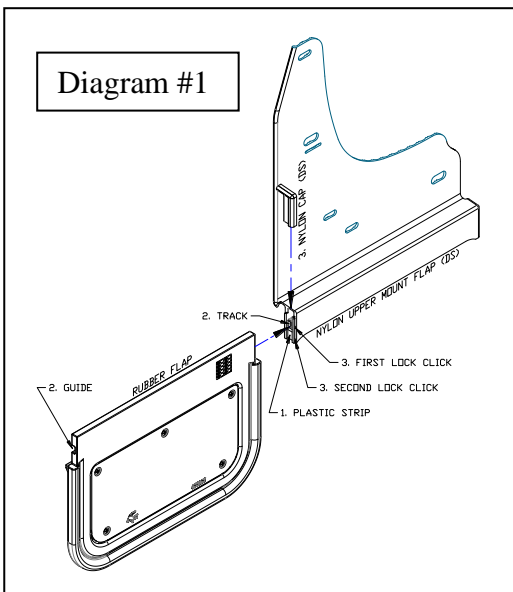

Please check out our YouTube channel to see an install video for this application.





19-20 GMC Sierra 1500 Nylon Mud Flap Set, 5/8" Offset, Rear Mounting Diagram & Instructions Kit# GCN29R

TO BE USED WITH SIERRA CAP PART #FC001K

IMPORTANT:

Manufacturer is not responsible for negligent use of vehicle with mud flaps installed, including over-tightening of screws and bolts causing damage to vehicle or mud flaps.

TOOLS REQUIRED-

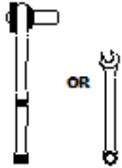

7/16" Open Wrench or
Socket Wrench

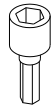

1/4" Socket Driver

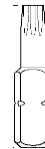

T15 Torx Bit

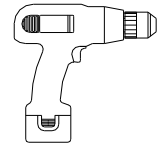

Electric or Rechargeable
Drill

FLAPS

(1) Flap Assy
Rear, DS
Part #768351

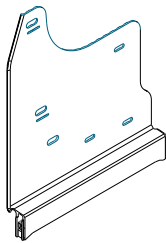

(1) Flap Assy
Rear, PS
Part #768352

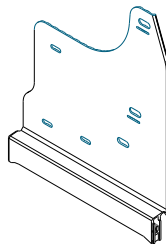

(2) Rubber Flap
Universal
12" x 8-3/4"

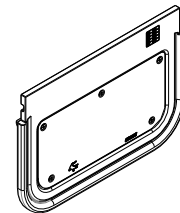

(1) Nylon Cap
Driver Side
Part #080642

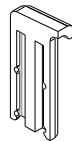

(1) Nylon Cap
Passenger Side
Part #080643

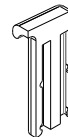

PARTS BAG # 767778

a) (6) Washer, Flat
0.281" x 1", 18g, SS, ox.
Part #018069

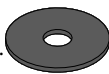

b) (6) Washer, Flat
0.203" x 1", 18g, SS, ox.
Part #018070

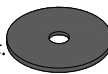

c) (6) Cap Screw, Black Ox.
1/4"-20UNC x 5/8"
Part #014071



d) (6) Screw, Sheet Metal, Blk Ox.
1/4" Hex Washer Head, #8-18x1"
Part # 016055



e) (2) Mud Flap Clip
Driver Side
Part # 769312

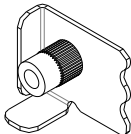

f) (2) Mud Flap Clip
Passenger Side
Part #769313

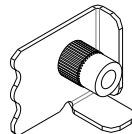

g) (2) Spring Nut
1/4"-20UNC, 27/32" Reach
Part #028006



h) (2) Washer, Flat
5/16" x 1" HDPE
Part #018036



SOLD SEPARATELY: FC001K FINISHING CAPS

(1) Molded Cap
Driver's Side

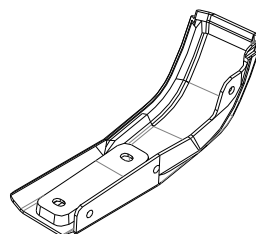

(1) Molded Cap
Passenger's Side

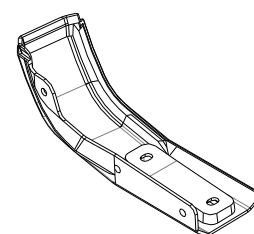

INSTALLATION - Start with installation of Truck Hardware Finishing Cap

(For ease of installation it is suggested that the wheel be removed)

CAPS:

1. Remove the 4 factory screws from the existing factory guard. Set this hardware aside for later reinstallation.
2. Use a 5/16" socket on an extension to collapse the push pin on the inside of the factory cap. You can reach the push pin through the cavity of the fender (See video).
3. Slightly peel back the red 3M tape on the finishing cap and fold back so it can be fully peeled after cap is in place.
4. Position cap, ensuring the top lip of the cap slides under the fender molding as shown.
5. If installing Gatorback Mud Flaps, reinstall the two factory screws on the underside of the finishing cap. If no flaps are being installed, reinstall the four factory screws to secure the cap. Be careful not to overtighten.
Note On the rear caps, the empty screw slot on the cap is specifically for our Gatorback mud flap installation and has no corresponding factory screw.
6. Finish peeling 3M tape and press firmly on the bottom and side of the finishing cap to ensure a proper seal.
7. Repeat procedure on passenger side.

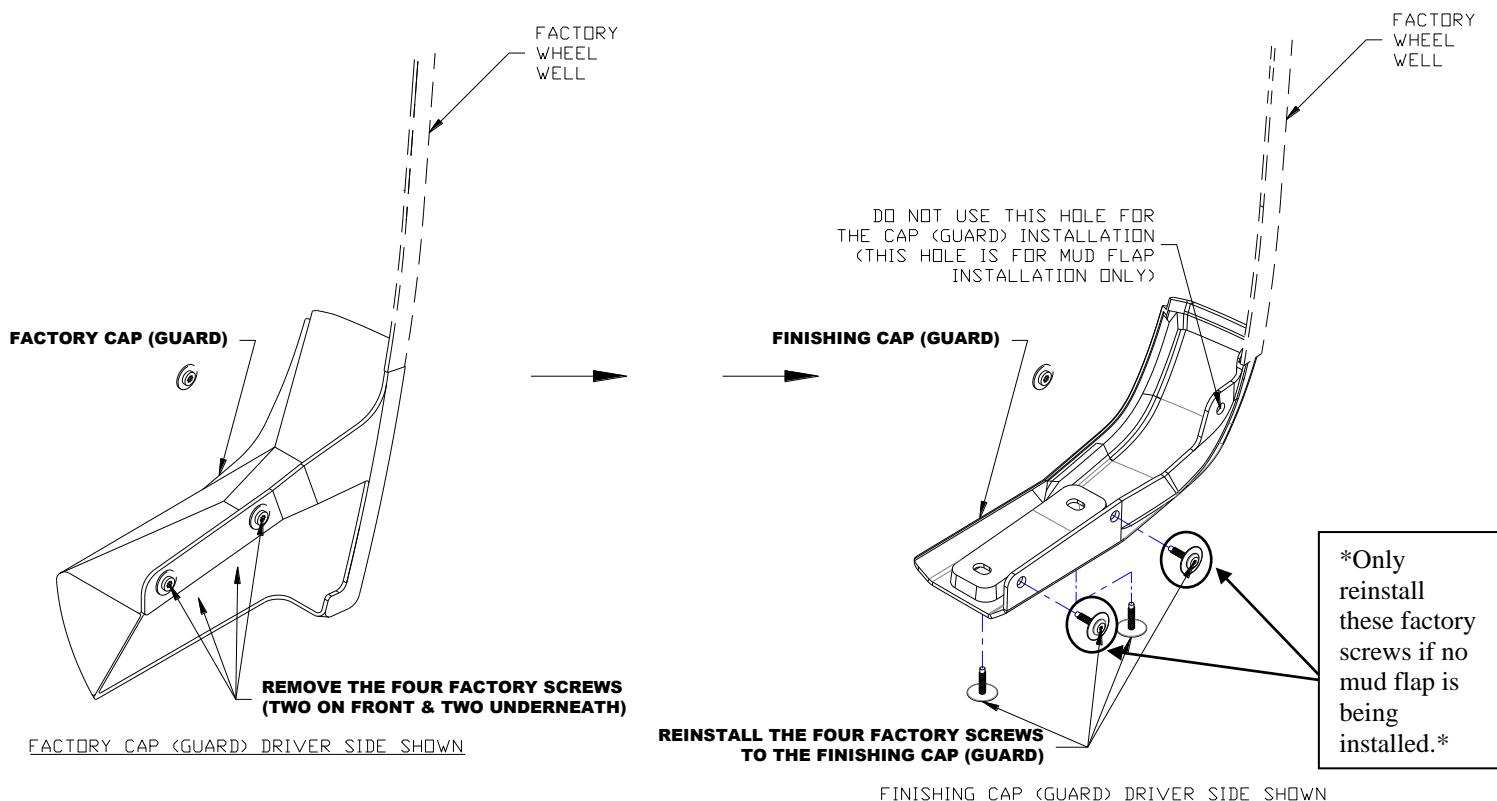

Please check out our YouTube channel to see an install video for this application.



Sierra Rear

ASSEMBLY OF NYLON MUD FLAP:

1. Remove and discard the plastic strip inside the track at the bottom of the nylon upper mount. (See Diagram #1).
2. Slide rubber guide into track of nylon upper mount.
3. Install included cap(s) on bottom of nylon upper mount. To fully lock this cap into place, you should hear two clicks, and cap will be even with the offset part of the upper mount. (See Diagram #1).
4. Repeat Procedure for second mud flap.

MUD FLAPS:

2. Before you install your Mud Flap Set, see the diagram and parts list for all necessary parts. Start on the driver's side.
2. Remove factory screw from wheel well hole #9. *Note* Factory screws on holes #7 & #8 will have been removed during cap installation.
3. Install spring nut (g) on finishing cap hole #12.
4. Loosely install mount clips (e) to mud flap holes #1 & #2 using a cap screw (c) and flat washer (a)
5. Secure mud flap through hole #3 into factory hole #9 using supplied screw (d), washer (b), and plastic washer (h).
6. Secure mud flap in holes #1 & #2 using mount clips (e) #10 & #11 behind fender lip.
7. Secure the mud flap through hole #6 into spring nut on hole #12 using supplied bolt (c) and washer (a). Loosely secure at this point.
8. Secure mud flap through holes #4 & #5 into plastic cap holes #7 & #8 supplied screws (d) and washers (b). Loosely secure at this point
9. Using a bubble level or other levelling tool, ensure that the mud flap is level. Tighten fasteners.
10. Repeat procedure for passenger side.

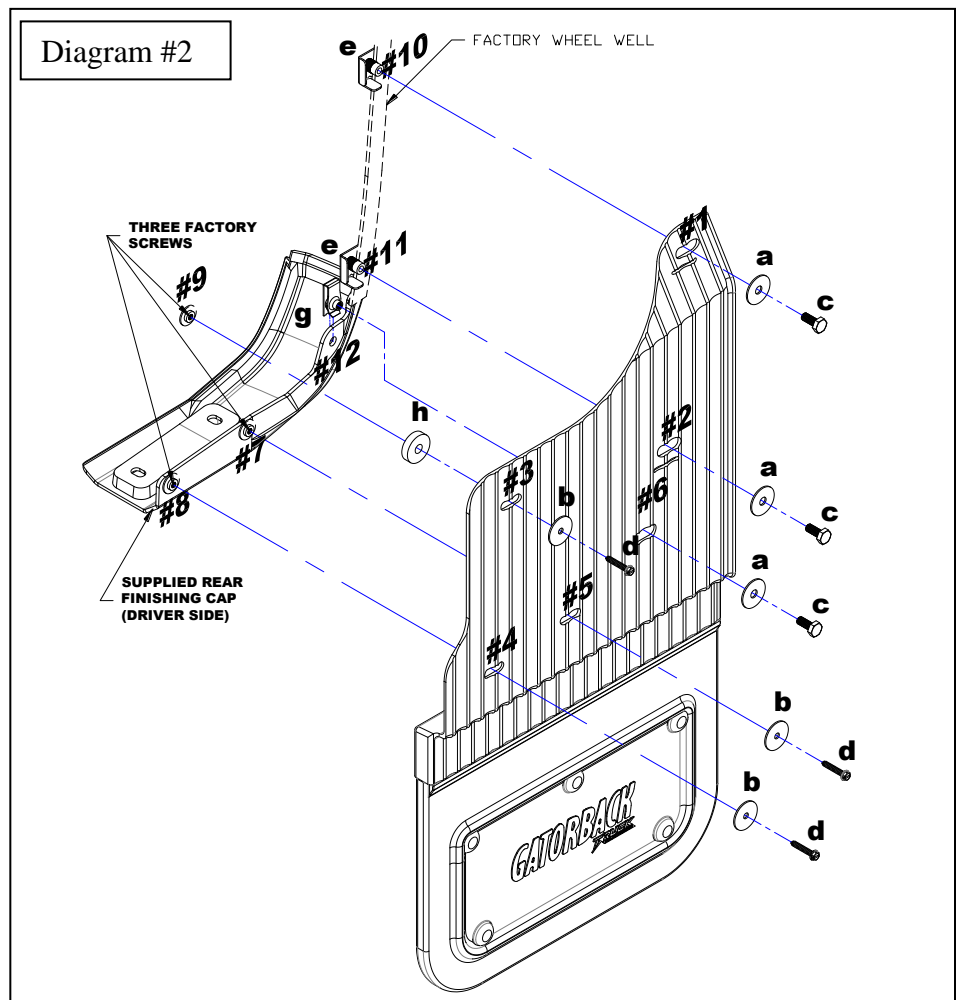
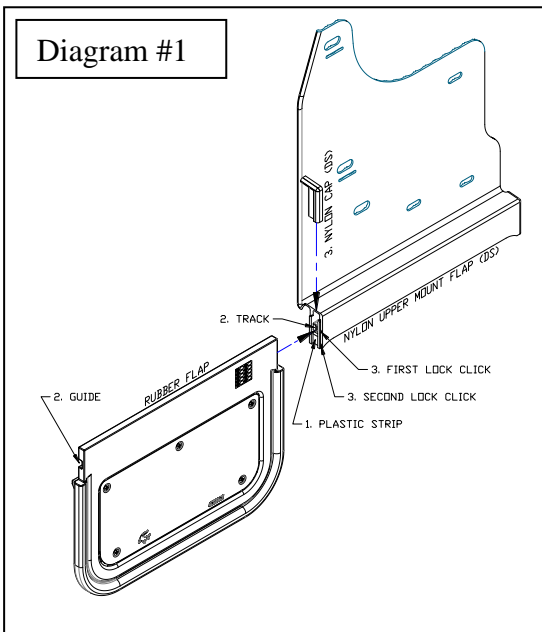

Please check out our YouTube channel to see an install video for this application.

