



2017-23 Buick Encore (Excludes GX)
2017-23 Chevrolet Trax
Mud Flap Set, Front
Mounting Diagram & Instructions
Kit# GCR24F
 766686/766699

IMPORTANT:

Manufacturer is not responsible for negligent use of vehicle with mud flaps installed, including over-tightening of screws and bolts causing damage to vehicle or mud flaps.



TOOLS REQUIRED-

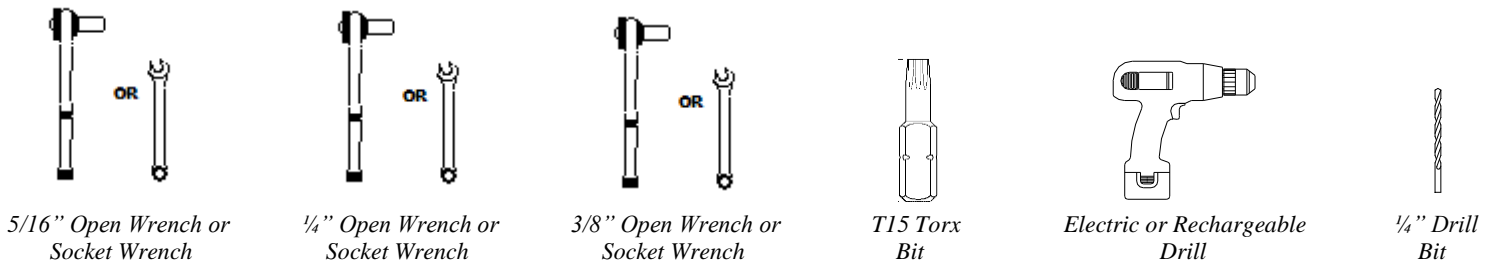

FLAPS

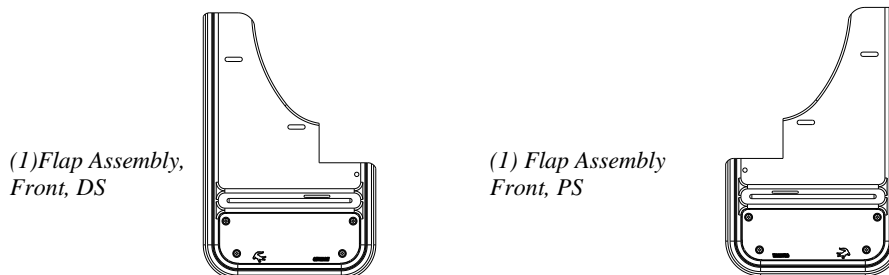

PARTS BAG # 766692

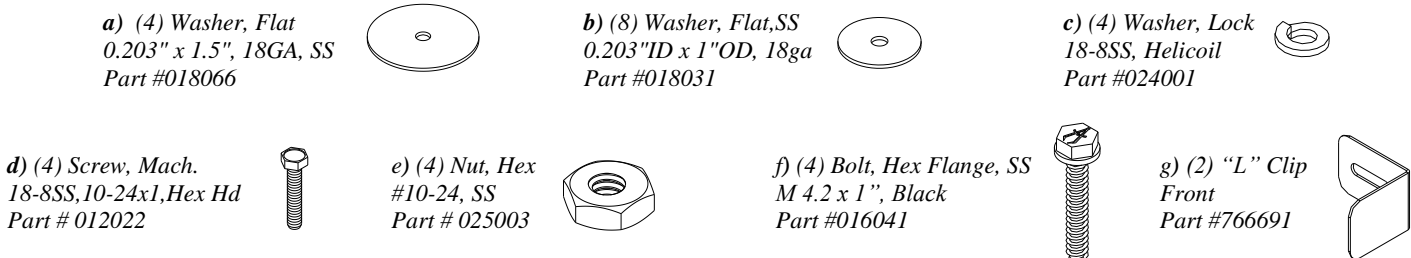

INSTALLATION (For ease of installation it is suggested that the wheel be removed)

1. Before you install your Mud Flap Set, see the diagram and parts list for all necessary parts. Start on the driver's side.
2. Remove the 2 factory screws in the wheel well and 1 factory push pin from the bottom of fender.
3. Install mud flap to fender through holes #1 and #2 into holes #5 and #6 using a stainless steel bolt (#016041) and a stainless steel washer (#018066). Loosely secure at this point.
4. Install "L" bracket through hole #3.



- Using a bubble level or square, ensure that the mud flap is level. Viewing the vehicle from the back, the outer edge of the mud flap should appear parallel to the tires. Tighten fasteners on holes #1 and #2.
- Secure “L” bracket to fender through hole #7 using one machine screw (#012022), two stainless steel washers (#018031), one lock washer (#024001), and one hex nut (#025003).
- Drill a 1/4” hole through mud flap hole #4 into liner (#8).
- Secure flap through hole #4 into fender hole #8 using one machine screw (#012022), two stainless steel washers (#018031), one lock washer (#024001), and one hex nut (#025003).
- Carefully tighten all fasteners and ensure that the mud flap has remained level.
- Repeat procedure for the passenger side.

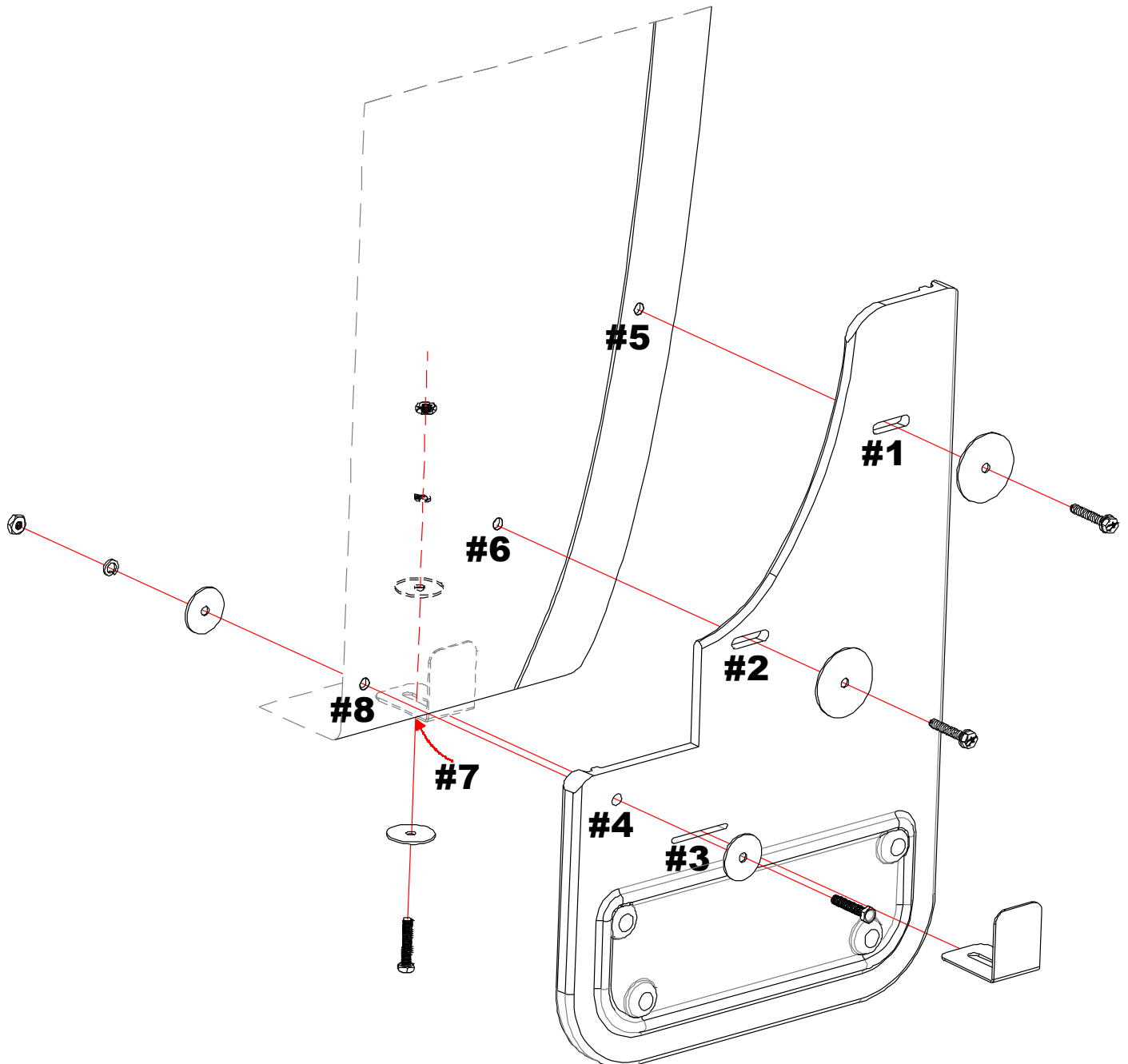

Please check out our YouTube channel to see an install video for this application.





2017-23 Buick Encore (Excludes GX)
2017-23 Chevrolet Trax
Mud Flap Set, Rear
Mounting Diagram & Instructions
Kit# GCR24R
766693/766702

IMPORTANT:

Manufacturer is not responsible for negligent use of vehicle with mud flaps installed, including over-tightening of screws and bolts causing damage to vehicle or mud flaps.



TOOLS REQUIRED-

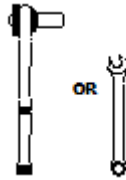

5/16" Open Wrench or
Socket Wrench

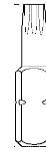

T15 Torx
Bit

FLAPS

(1) Flap Assembly,
Front, DS

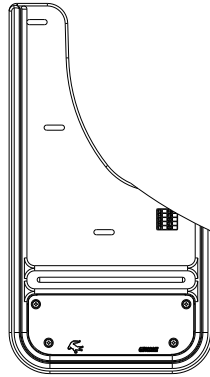

(1) Flap Assembly
Front, PS

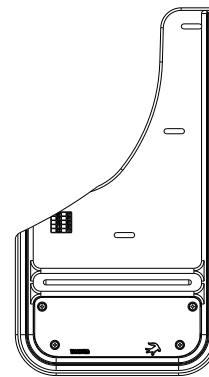

PARTS BAG # 766698

a) (6) Washer, Flat
0.203" x 1.5", 18GA, SS
Part #018066

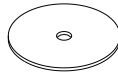

f) (6) Bolt, Carriage, SS
1/4"-20x1.5"
Part #016041

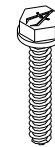

INSTALLATION (For ease of installation it is suggested that the wheel be removed)

2. Before you install your Mud Flap Set, see the diagram and parts list for all necessary parts. Start on the driver's side.
2. Remove the 3 factory screws from the fender.
3. Starting on the bottom hole, install the mud flap to fender through holes #1 to #3 into holes #4 to #6 using a stainless steel bolt (#014016) and a stainless steel washer (#018066). Loosely secure at this point.
4. Using a bubble level or square, ensure that the mud flap is level. Viewing the vehicle from the back, the outer edge of the mud flap should appear parallel to the tires.



- Carefully tighten all fasteners and ensure that the mud flap has remained level.
- Repeat procedure for the passenger side.

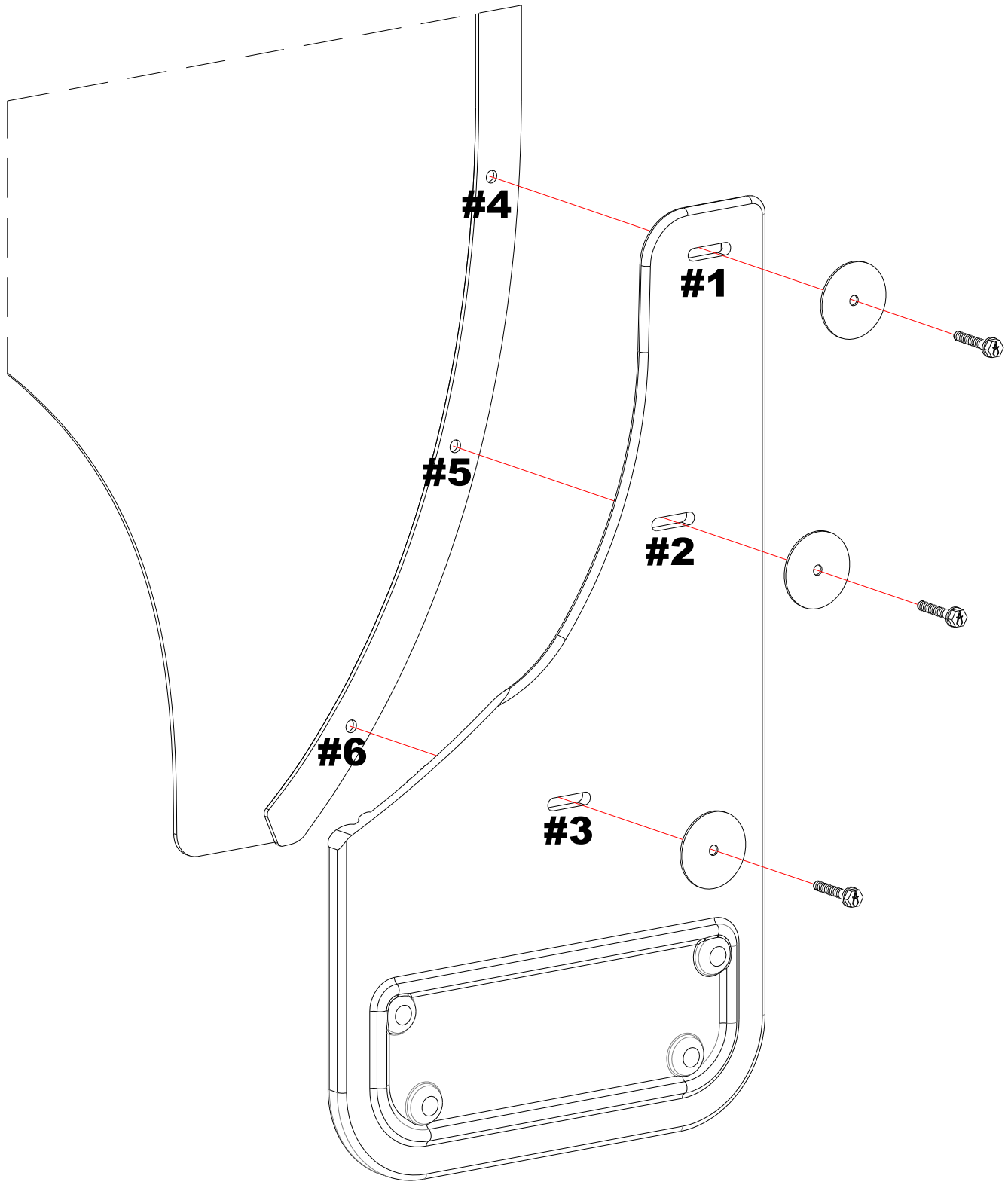

Please check out our YouTube channel to see an install video for this application.

