

IMPORTANT:

Manufacturer is not responsible for negligent use of vehicle with mud flaps installed, including over-tightening of screws and bolts causing damage to vehicle or mud flaps.

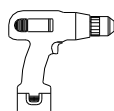

TOOLS REQUIRED



Electric or Chargeable
 1/2" or 3/8" Drill



3/8" Socket Driver



1/4" Drill Bit

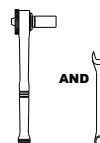

5/16 & 3/8" Open End
 Wrench & Socket Wrench

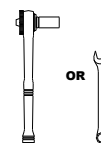

10mm open end or
 Socket Wrench

FLAPS

(1) Flap Assembly,
 Front, DS

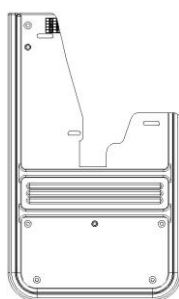

(1) Flap Assembly,
 Front, PS

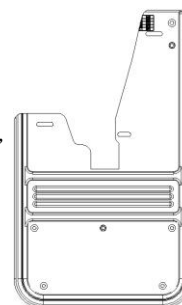

PARTS BAG # 766126

a) (8) Washer, Flat
 0.203" x 1", SS
 Part #018031



b) (2) Washer, Lock
 #10, Helicoil, SS
 Part #024001



c) (2) Hex Nut
 #10, SS
 Part #025003



d) (2) Mach. Screw
 #10-24 x 1", SS
 Part #012022



INSTALLATION (For ease of installation it is suggested that the wheel be removed)

1. Before you install your Gatorback Mud Flap, see the diagram and parts list for all necessary parts.
2. Remove two (2) factory screws #4 & #5. Using the two (2) factory screws and included washers, reinstall on holes #1 & #2. Loosely secure at this point.
3. Square the flap with the tire, while putting pressure against the wheel well, then tighten the two (2) factory screws #4 & #5.
4. Hold flap tight against wheel well and drill 1/4" hole (1), from the center of the slotted hole #3 through the factory plastic liner. Secure the flap with one (1) machine screw #012022, two (2) flat washers #018031, one (1) lock washer #024001 and one (1) hex nut #025003.
5. Repeat procedure for passenger side.

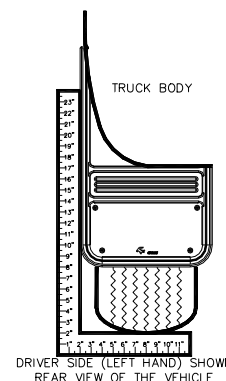

REMOVE THE FACTORY SCREWS AND REINSTALL THROUGH HOLES #1 AND #2

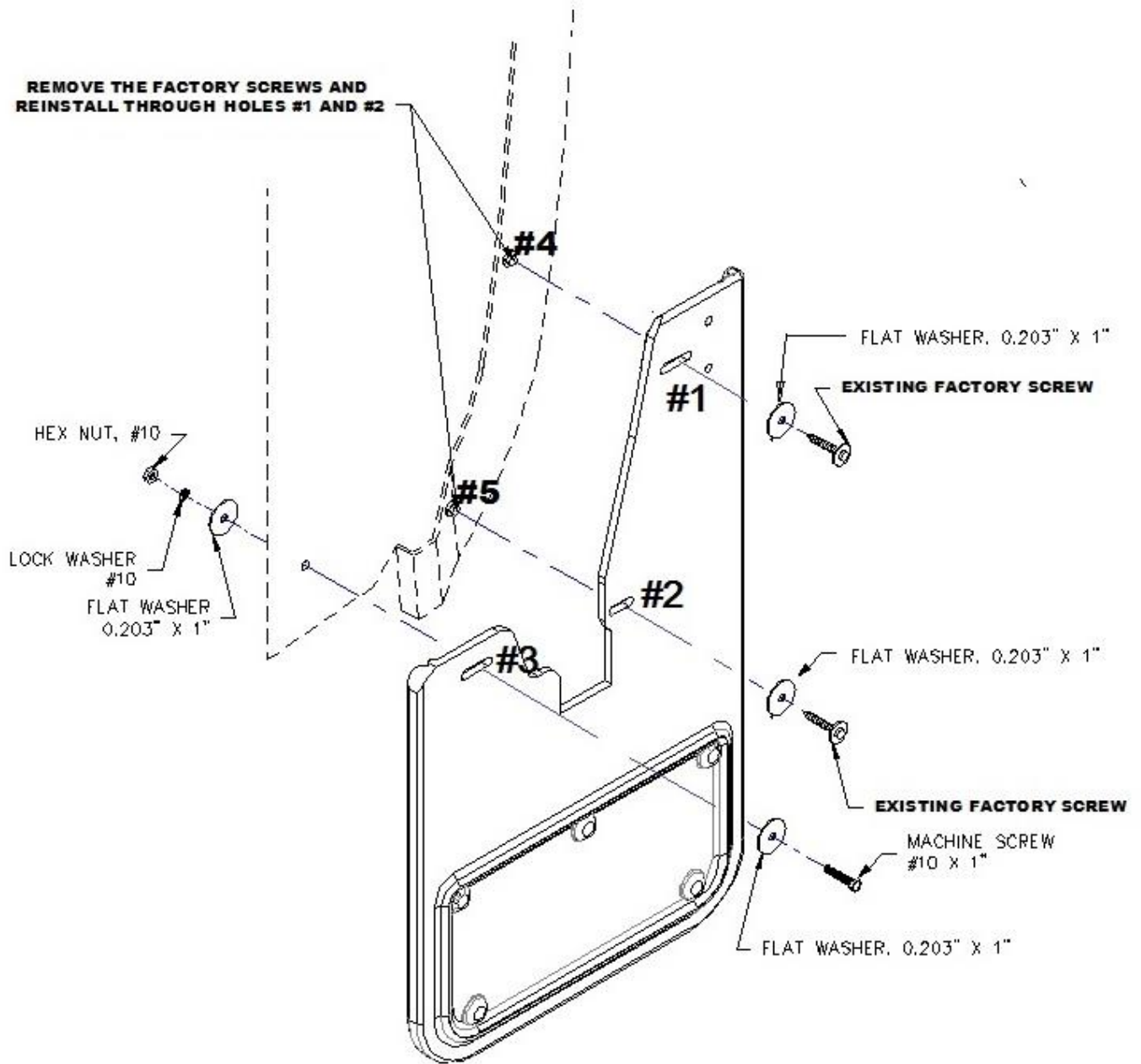

Please check out our YouTube channel to see an install video for this application.



1520 - 33 St N · Lethbridge, AB T1H 5H3 · Canada
Toll free: 1-800-661-8208 · Email: info@truckhardware.ca · www.truckhardware.ca

