

**IMPORTANT:**

**Manufacturer is not responsible for negligent use of vehicle with mud flaps installed, including over-tightening of screws and bolts causing damage to vehicle or mud flaps.**

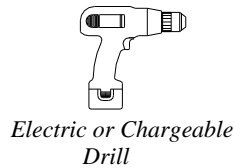

## TOOLS REQUIRED

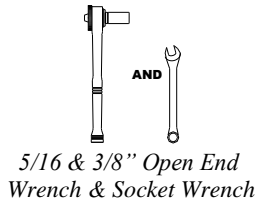

## FLAPS

(1) Flap Assembly, Rear, DS

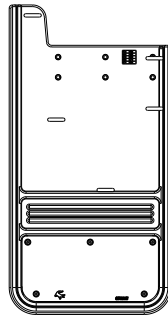

(1) Flap Assembly, Rear, PS

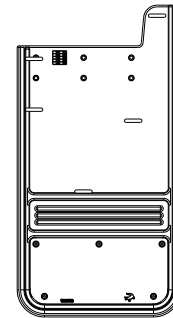

## PARTS BAG # 767498

a) (6) Washer, Flat 0.203" x 1", SS Part #018081



b) (6) Washer, Lock #10, Helicoil, SS Part #024001



c) (6) Hex Nut #10, SS Part #025003



d) (6) Mach. Screw #10-24 x 1", SS Part #012022

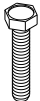

e) (4) Screw, Sheet Metal #10-14 x 1.25", SS Part #016052



f) (6) Washer, Flat, SS 0.203" x 0.781", 20ga Part #018018

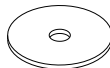

g) (4) Washer, Offset, Flat, SS 0.203" x 1.5", SS Part #018077



## INSTALLATION (For ease of installation it is suggested that the wheel be removed)

**\*Note\*** Please see mounting diagram for important details regarding with flare and without flare applications. For ease of installation, it is suggested that the wheel be removed.

1. Before you install your Gatorback Mud Flap, see the diagram and parts list for all necessary parts.
2. Remove the 2 factory bolts from holes #1 and #2 in the fender.
3. Loosely secure mud flap through hole #3 into factory hole #2 and through hole #4 into factory hole #1 using a stainless steel screw (016052) and an offset flat washer (018077). \*\*Note: for trucks WITHOUT flare, use center hole in washer, for trucks WITH flare, use offset hole in washer (See Diagram on Page 2)\*\*
4. Using a bubble level or square, ensure that the mud flap is level. Viewing the vehicle from the back, the outer edge of the mud flap should appear parallel to the tires.

5. Carefully tighten all fasteners. Ensure that the mud flap has remained level.
6. Using a ¼" drill bit, drill through mud flap holes #5 to #7 to create holes #8 to #10 in the factory liner.
7. Attach flap to plastic liner through mud flap hole #5 into liner hole #8, mud flap hole #6 into liner hole #9 and mud flap hole #7 into liner hole #10 with a machine screw (012022), a stainless steel washer (018081), and secure with a stainless steel washer (018018), a lock washer (024001), and a hex nut (025003).
8. Tighten all fasteners.
9. Repeat procedure on passenger side.

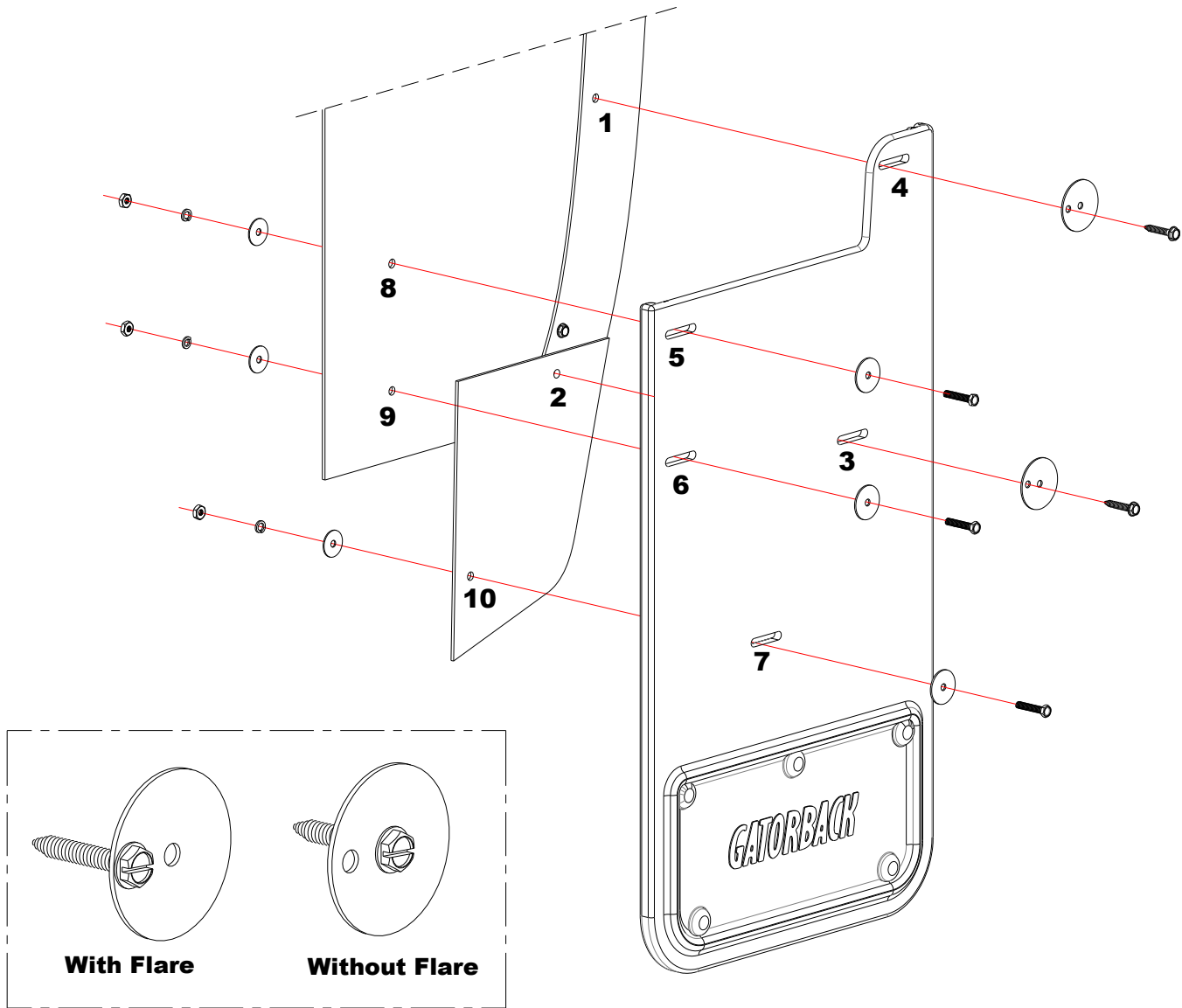

Please check out our YouTube channel to see an install video for this application.



1520 - 33 St N · Lethbridge, AB T1H 5H3 · Canada  
 Toll free: 1-800-661-8208 · Email: info@truckhardware.ca · www.truckhardware.ca

