



# GATORBACK

## MUDFLAPS

## 22-24 Ford Expedition Mud Flap Set, Stainless, Rear Mounting Diagram & Instructions 770565/770568/770571/770576/770683/770719

### IMPORTANT:

**Manufacturer is not responsible for negligent use of vehicle with mud flaps installed, including over-tightening of screws and bolts causing damage to vehicle or mud flaps.**



### TOOLS REQUIRED-

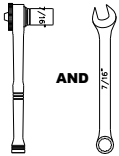

7/16" Socket Wrench  
and Open Wrench



Push Pin Removal Tool



Philips  
Screwdriver

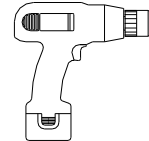

Electric or re-chargeable  
Drill



1/4" Drill Bit

### FLAPS

(1) Flap Assembly,  
Front, DS

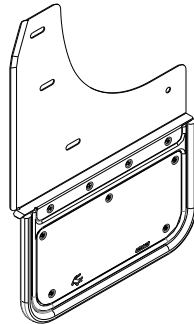

(1) Flap Assembly  
Front, PS

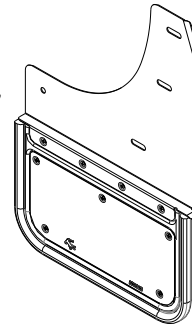

### PARTS BAG # 770564

a) (8) Capscrew,  
1/4"-20 x 1", SS  
Part #014007

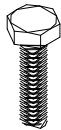

b) (10) Washer, Flat  
0.281" x 1", 18ga, SS  
Part #018068

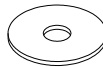

c) (2) Washer, Lock  
1/4" SS,  
Part #024000



d) (2) Nut, Hex  
1/4-20, SS  
Part #025000



e) (6) Spring Nut  
1/4-20 x 0.54" Reach  
Part #028010



f) (2) Durashield  
5/8" X 13" Protection Tape  
Part #766424



### INSTALLATION (For ease of installation it is suggested that the wheel be removed)

1. Before you install your Mud Flap Set, see the diagram and parts list for all necessary parts.
2. Remove the four factory push pins located on the inner fender.
3. Pull back the liner and install spring nuts (e) to the two upper tabs and the bottom tab that hold the liner in place.
4. Hold the mud flap in place and use a marker to mark about 1/4" above the mud flap.

5. Install durastrip (f) from the mark down the edge of the vehicle. This protects the paint and body from the mud flap.
6. Loosely install mud flap holes #1 to #3 to spring nuts (e) using a capscrew (a) and flat washer (b).
7. Push the mud flap hole #4 against the factory liner and drill a 1/4" hole through the mud flap hole into the factory liner.
8. Loosely install mud flap hole #4 to liner using a capscrew (a) and flat washer (b) and secure using a flat washer (b), lock washer (c) and hex nut (d).
9. Using a square or another levelling tool, ensure that the mud flap is level. Tighten all fasteners.
10. Repeat procedure on passenger side.

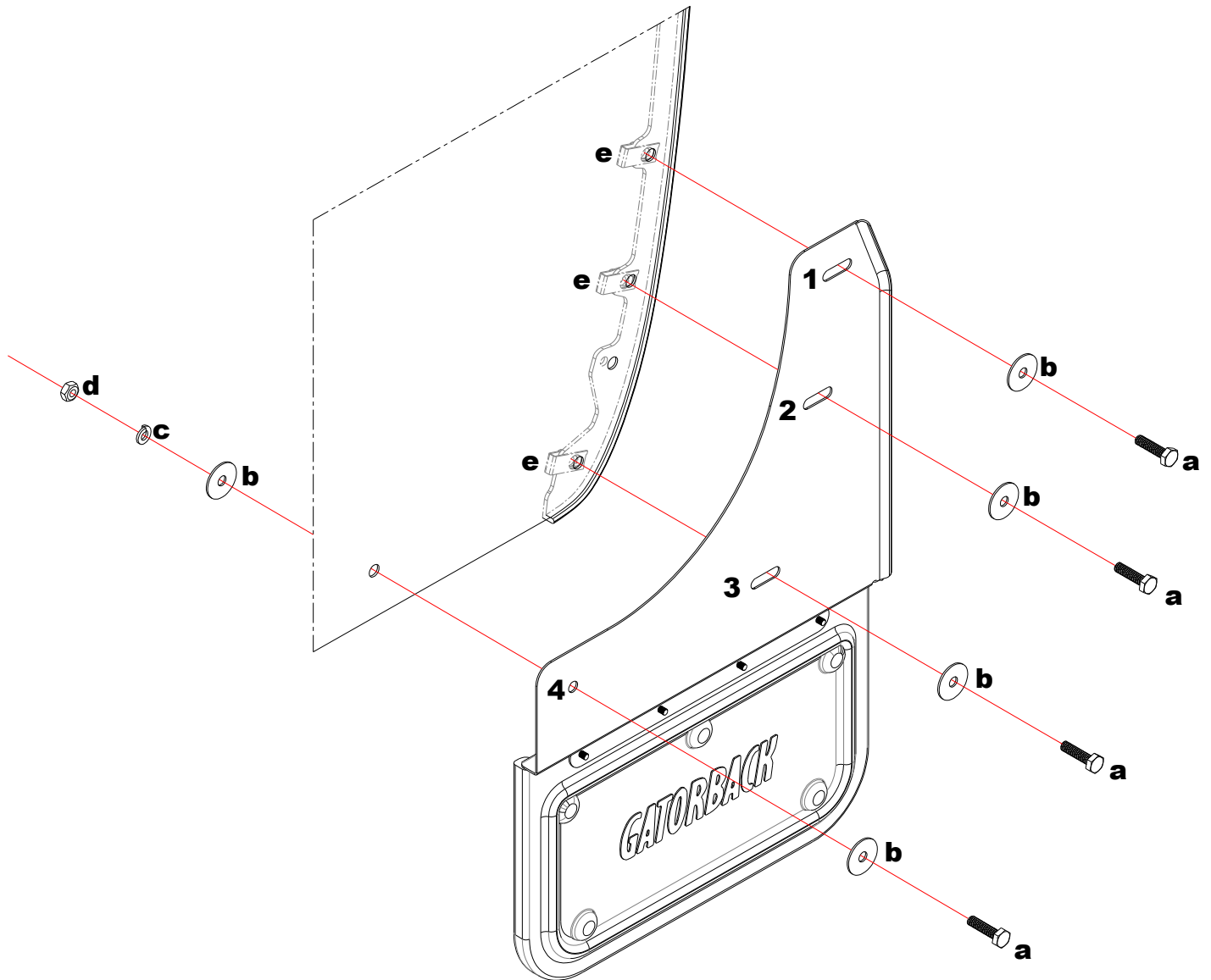

Please check out our YouTube channel to see an install video for this application.

