

2009-2018 Ram 1500

2019 Ram 2500 / 3500 (Old Body and New Body)

No-Drill Front Rubber Mud Flap Set

Mounting Diagram & Instructions

Kit's # RCR31F / RCR32F



IMPORTANT:

Manufacturer is not responsible for negligent use of vehicle with mud flaps installed, including over-tightening of screws and bolts causing damage to vehicle or mud flaps.

NO-DRILL SYSTEM

TOOLS REQUIRED

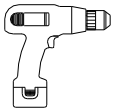

Electric or Chargeable
1/2" or 3/8" Drill



3/8" Socket Driver



1/4" Drill Bit

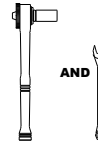

AND



5/16 & 3/8" Open End
Wrench & Socket Wrench

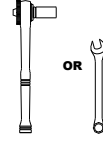

OR

10mm open end or
Socket Wrench

FLAPS

(1) Flap Assembly,
Front, DS

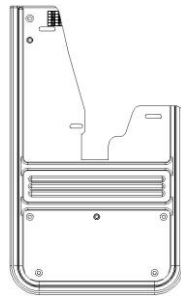

(1) Flap Assembly,
Front, PS

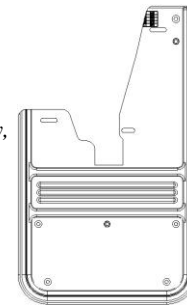

PARTS BAG # 766126

a) (8) Washer, Flat
0.203" x 1", SS
Part #018031



b) (2) Washer, Lock
#10, Helicoil, SS
Part #024001



c) (2) Hex Nut
#10, SS
Part #025003



d) (2) Mach. Screw
#10-24 x 1", SS
Part #012022



INSTALLATION

1. Before you install your Gatorback Mud Flap, see the diagram and parts list for all necessary parts.
2. Remove two (2) factory screws #4 & #5. Using the two (2) factory screws and included washers, reinstall on holes #1 & #2. Loosely secure at this point.
3. Square the flap with the tire, while putting pressure against the wheel well, then tighten the two (2) factory screws #4 & #5.
4. Hold flap tight against wheel well and drill 1/4" hole (1), from the center of the slotted hole #3 through the factory plastic liner. Secure the flap with one (1) machine screw #012022, two (2) flat washers #018031, one (1) lock washer #024001 and one (1) hex nut #025003.
5. Repeat procedure for passenger side.

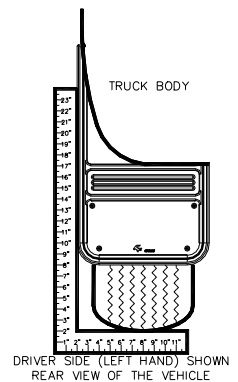

REMOVE THE FACTORY SCREWS AND REINSTALL THROUGH HOLES #1 AND #2

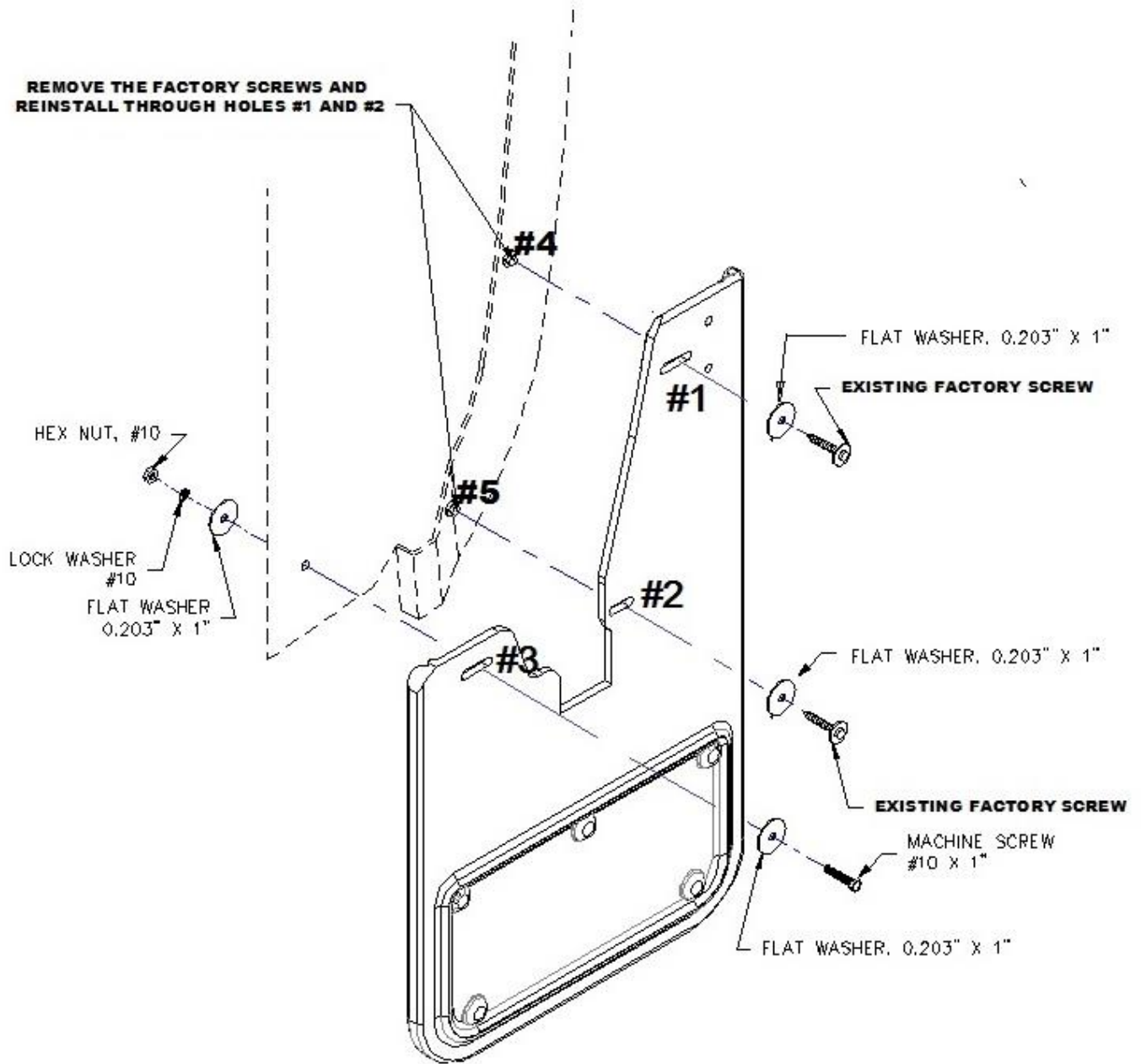

Please check out our YouTube channel to see an install video for this application.



1520 - 33 St N · Lethbridge, AB T1H 5H3 · Canada
Toll free: 1-800-661-8208 · Email: info@truckhardware.ca · www.truckhardware.ca





2009-2018 Ram
No-Drill Rear Rubber Mud Flap Set
Mounting Diagram & Instructions
Kit # RCR33R

IMPORTANT:

Manufacturer is not responsible for negligent use of vehicle with mud flaps installed, including over-tightening of screws and bolts causing damage to vehicle or mud flaps.

NO-DRILL SYSTEM

TOOLS REQUIRED

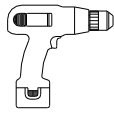

*Electric or Chargeable
 1/2" or 3/8" Drill*



3/8" Socket Driver



1/4" Drill Bit

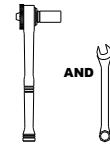

*5/16 & 3/8" Open End
 Wrench & Socket Wrench*

FLAPS

*(1) Flap Assembly,
 Front, DS*

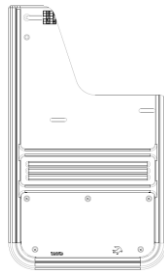

*(1) Flap Assembly,
 Front, PS*

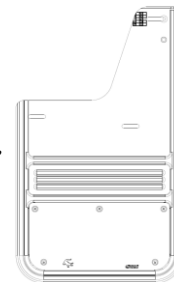

PARTS BAG # 766127

*a) (6) Washer, Flat
 0.203" x 1", SS
 Part #018031*

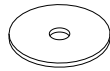

*b) (2) Washer, Lock
 #10, Helicoil, SS
 Part #024001*



*c) (2) Hex Nut
 #10, SS
 Part #025003*



*d) (2) Screw, Machine
 #10 x 1.5"
 Part #012027*

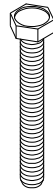

*e) (2) Washer, Half, SS
 0.203" x 1"
 Part #018032*

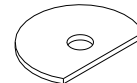

INSTALLATION

- Before you install your Gatorback Mud Flap, see the diagram and parts list for all necessary parts.
- Remove two (2) factory screws #4 & #5. Using the two (2) factory screws and included washers #018031, reinstall on holes #1 & #2. Loosely secure at this point.
- Square the flap with the tire, while putting pressure against the wheel well, then tighten the two (2) factory screws #4 & #5.
- Hold flap tight against wheel well and drill a 1/4" hole (1), from the center of the slotted hole #3 through the factory plastic liner. Secure the flap with one (1) machine screw #012027, one (1) flat washer #018031, one (1) half washer #018032, one (1) lock washer #024001 and one (1) hex nut #025003.
- Repeat procedure for passenger side.

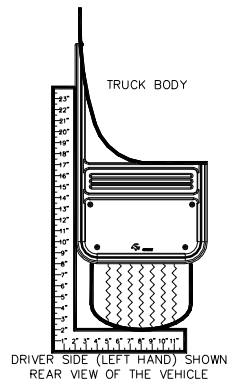

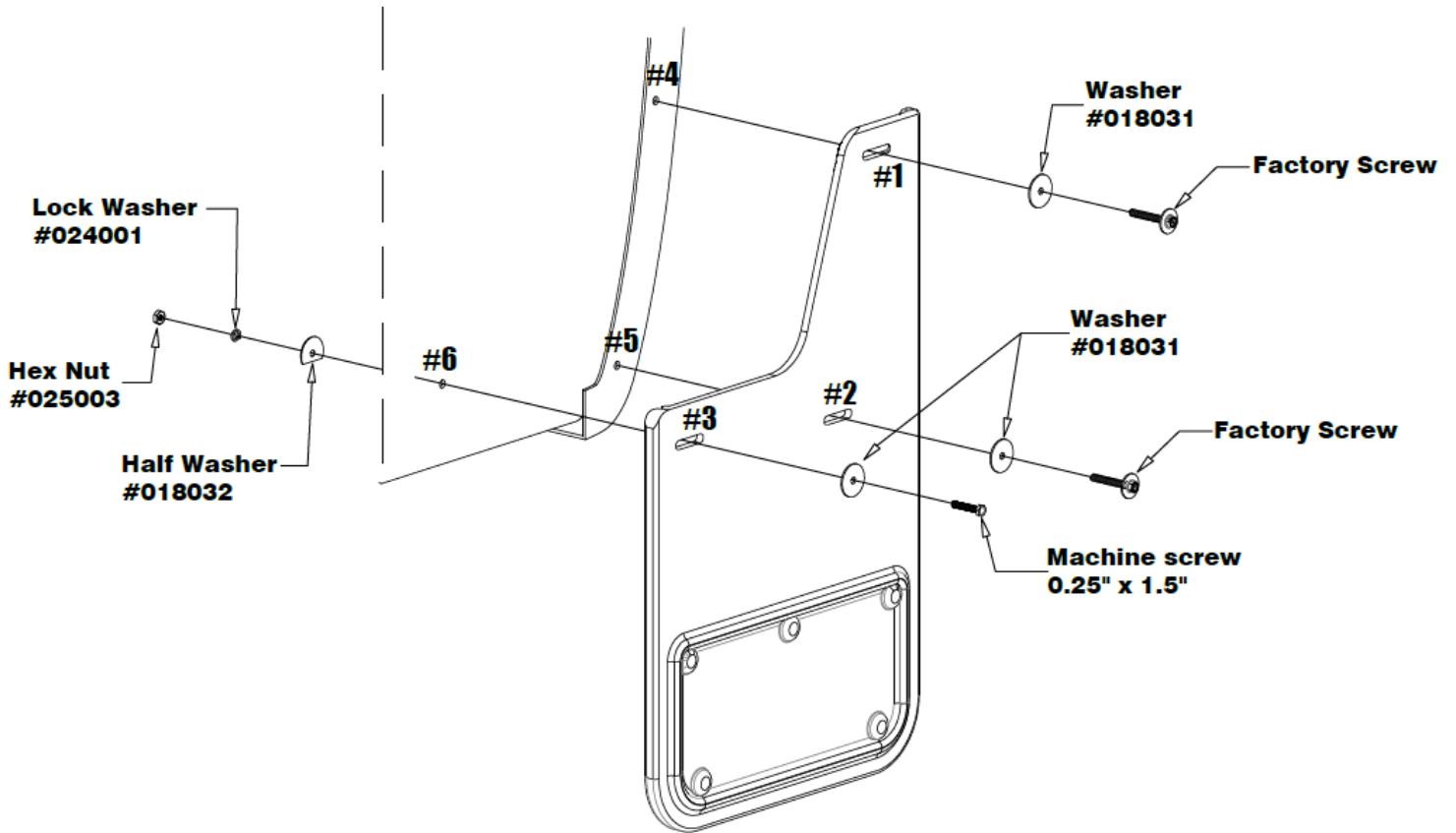

Please check out our YouTube channel to see an install video for this application. 