



# 2018-2022 Wrangler Rubicon Mud Flap Set, Front Mounting Diagram & Instructions GCN63F

## IMPORTANT:

Manufacturer is not responsible for negligent use of vehicle with mud flaps installed, including over-tightening of screws and bolts causing damage to vehicle or mud flaps.

## TOOLS REQUIRED-



Push Pin  
Removal Tool

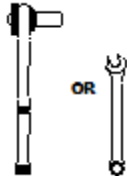

3/8" Open Wrench  
or Socket Wrench

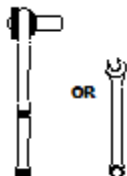

1/4" Open Wrench  
or Socket Wrench

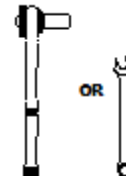

5/16" Open Wrench  
or Socket Wrench

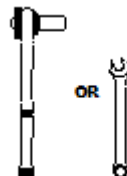

7/16" Open Wrench  
or Socket Wrench

## FLAPS/BRACKETS/LOCKING CAPS

(1) Upper Mount  
Front, DS

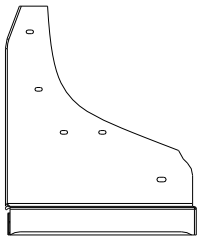

(1) Upper Mount  
Front, PS

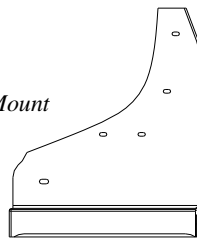

(1) Locking Cap  
DS  
Part #080642

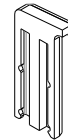

(1) Locking Cap  
PS  
Part #080643

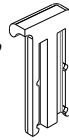

Please note: There will be a plastic piece in the upper mount channel. Please remove and discard.

(2) Rubber Flap  
Universal  
12" x 8-3/4"

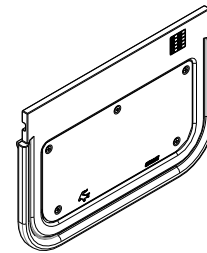

## PARTS BAG # 770550

a) (4) Machine Screw  
#10-24 x 1", SS Blk Ox.  
Part #012050

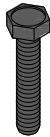

b) (2) Capscrew  
1/4"-20 x 1.5", SS, Blk Ox.  
Part #014074



c) (4) Sheet Metal Screw  
#8-18 x 1" SS Blk Ox.  
Part #016057



d) (4) Washer Flat  
0.203" x 0.781", SS  
Part #018018

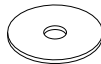

e) (2) Washer, Flat  
0.281" x 1" SS  
Part #018068

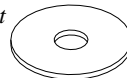

f) (2) Washer, Flat,  
0.281" x 1" OD, SS, Blk Ox.  
Part #018069



g) (4) Washer, Flat  
0.203" x 1" SS Blk Ox.  
Part #018070

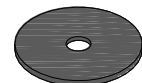

h) (4) Washer, Flat  
0.203" x 1.5" SS Blk Ox.  
Part #018080



i) (2) Washer, Lock  
1/4" Helicoil, SS  
Part #024000



j) (4) Washer, Lock  
18-8SS, 10  
Part #024001



k) (2) Hex Nut  
1/4"-20, SS  
Part #025000



l) (4) Hex Nut  
#10-24, SS  
Part #025003



m) (2) Spacer, Nylon, Blk  
1/4" x 1/2" x 7/8"  
Part #054082



n) (4) Clip  
Front  
Part #770552

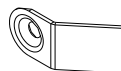

## INSTALLATION *(For ease of installation it is suggested that the wheel be removed)*

1. Before you install your mud flap and bracket set, see the diagrams and parts list for all necessary parts. Start on the driver's side.
2. Remove 3 factory push pins from the fender on factory holes #6 to #8
3. Loosely install clip (n) on mud flap hole #2 using a screw (c) and flat washer (h)
4. Install mud flap hole #4 to factory hole #7 using a machine screw (a) and flat washer (g) and secure with a flat washer (d), lock washer (j) and hex nut (l).
5. Slide clip (n) on mud flap hole #2 between flare and liner.
6. Install clip (n) between flare and liner, aligned with mud flap hole #1, and secure mud flap to clip using a screw (c) and flat washer (h)
7. Install mud flap hole #3 to factory hole #6 using a screw (a) and flat washer (g), and secure with a flat washer (d), lock washer (j), and hex nut (l)
8. Install mud flap hole #5 through spacer (m) into factory hole #8 using a bolt (b) and flat washer (f) and secure using a flat washer (e), lock washer (i), and hex nut (k).
9. Using a bubble or another leveling tool, ensure that the mud flap is level and tighten all fasteners.
10. Repeat procedure on passenger's side.

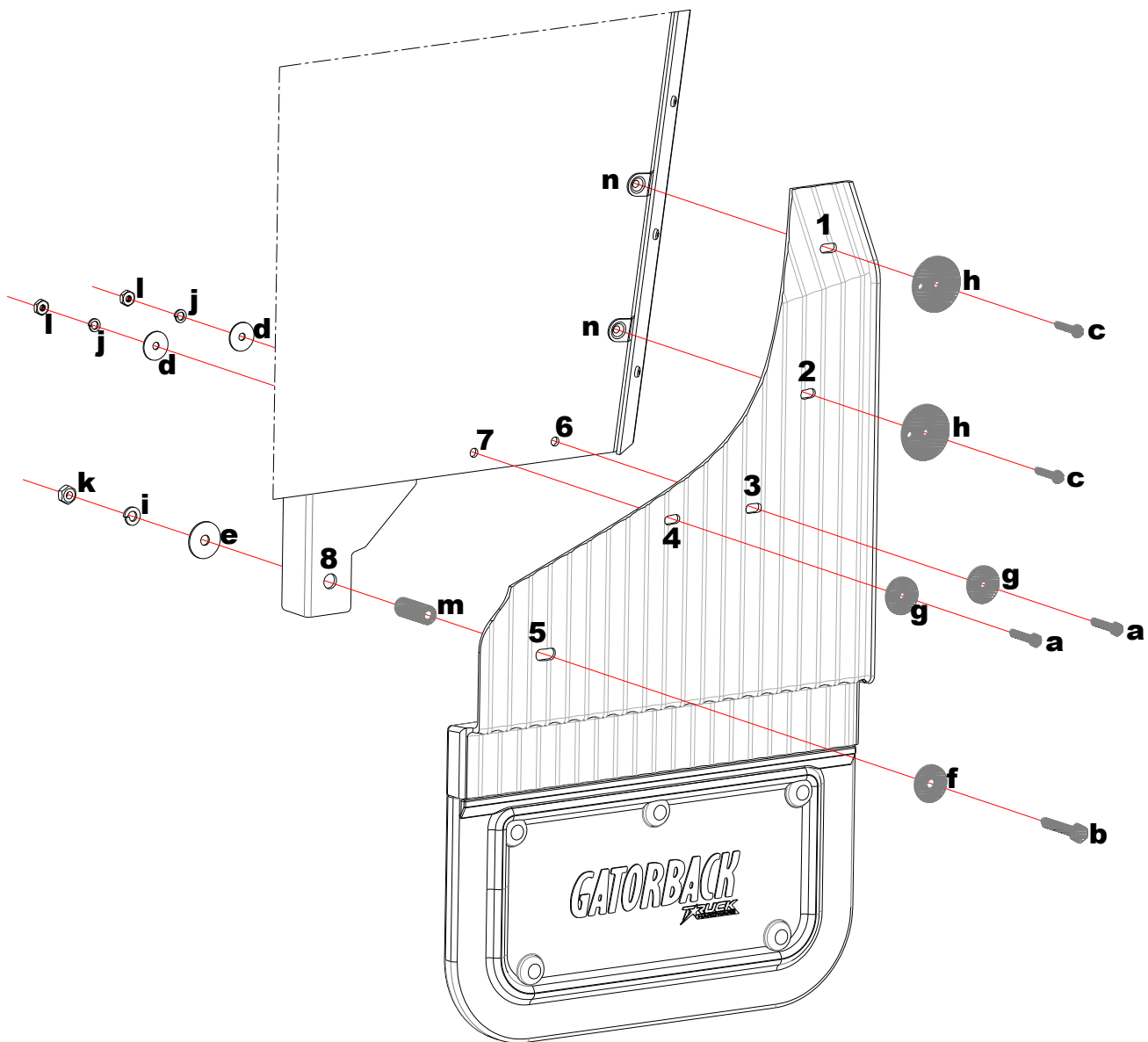

Please check out our YouTube channel to see an install video for this application



**IMPORTANT:**

**Manufacturer is not responsible for negligent use of vehicle with mud flaps installed, including over-tightening of screws and bolts causing damage to vehicle or mud flaps.**

**TOOLS REQUIRED-**

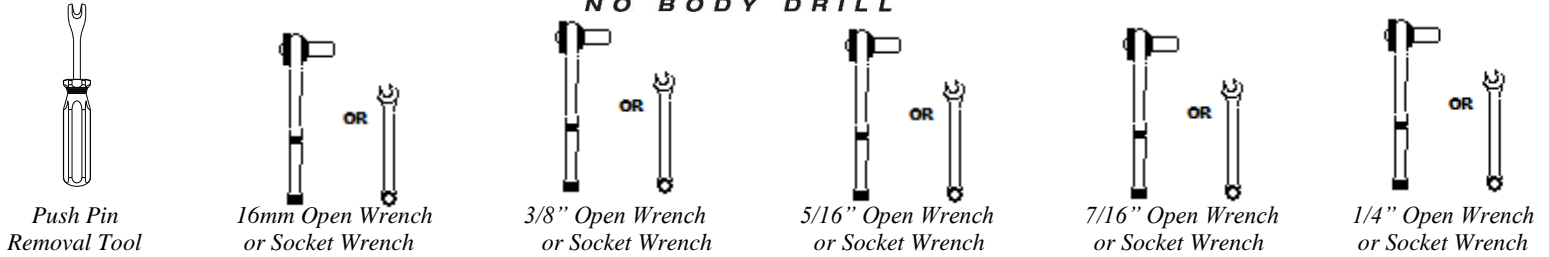

**FLAPS/BRACKETS/LOCKING CAPS**

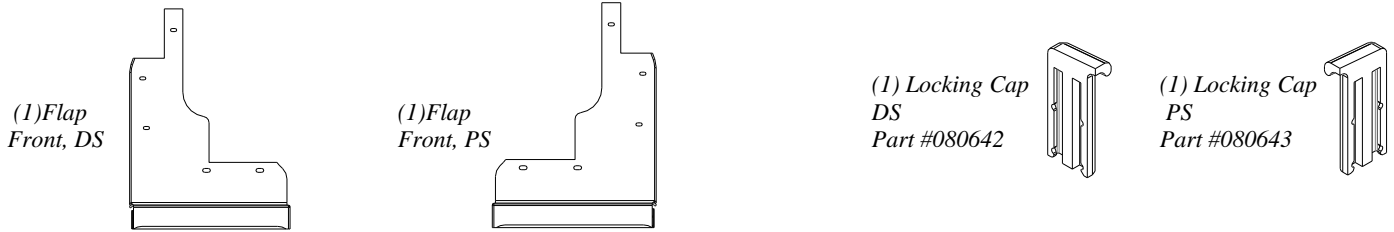

Please note: There will be a plastic piece in the upper mount channel. Please remove and discard.

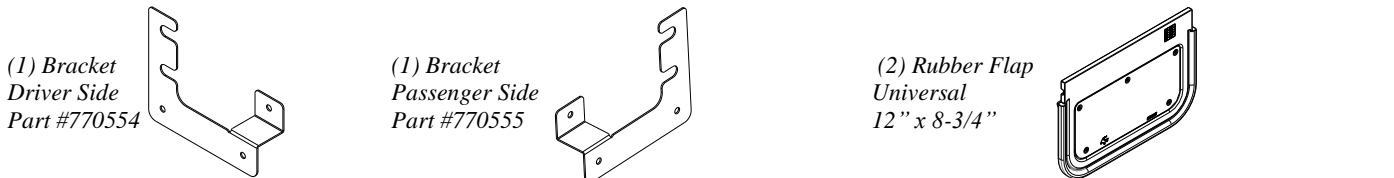

**PARTS BAG # 770551**

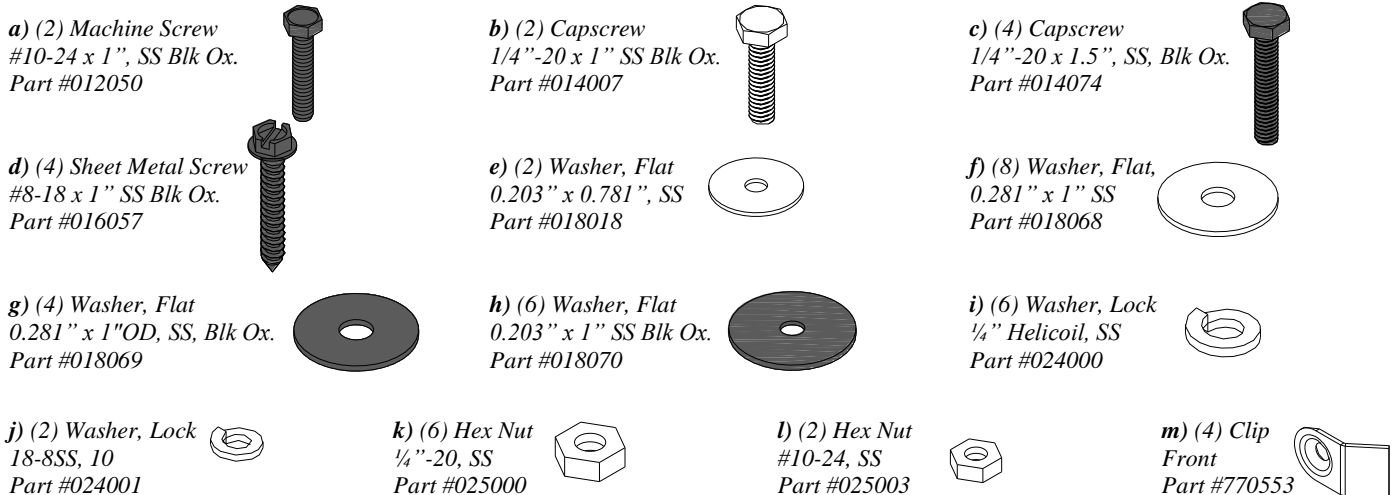

## INSTALLATION *(For ease of installation it is suggested that the wheel be removed)*

1. Before you install your mud flap and bracket set, see the diagrams and parts list for all necessary parts. Start on the driver's side.
2. Remove the lower fender liner by removing the 3 factory screws from the fender. Set aside for reinstallation later.
3. Loosen bumper bolts, slide bracket behind bolts, and install bracket to the factory hole using a bolt (b) and flat washer (f) and secure using a flat washer (f), lock washer (i), and hex nut (k). Tighten bumper bolts. (See Diagram #1).
4. Remove factory push pin from fender.
5. Install clips (m) on mud flap holes #2 & #3 using a screw (d) and flat washer (h). (See Diagram #2).
6. Install mud flap hole #1 to factory hole where push pin was removed using a machine screw (a) and flat washer (h), and secure using a flat washer (e), lock washer (j), and hex nut (l). (See Diagram #2).
7. Slide clips (m) behind fender.
8. Install mud flap holes #4 & #5 to bracket holes #6 & #7 using a bolt (c), and flat washer (g) and secure using a flat washer (f), lock washer (i), and hex nut (k). (See Diagram #2).
9. Using a bubble or another leveling tool, ensure that the mud flap is level and tighten all fasteners.
10. Reinstall the factory cover using the factory hardware removed in step 2.
11. Repeat procedure on passenger's side.

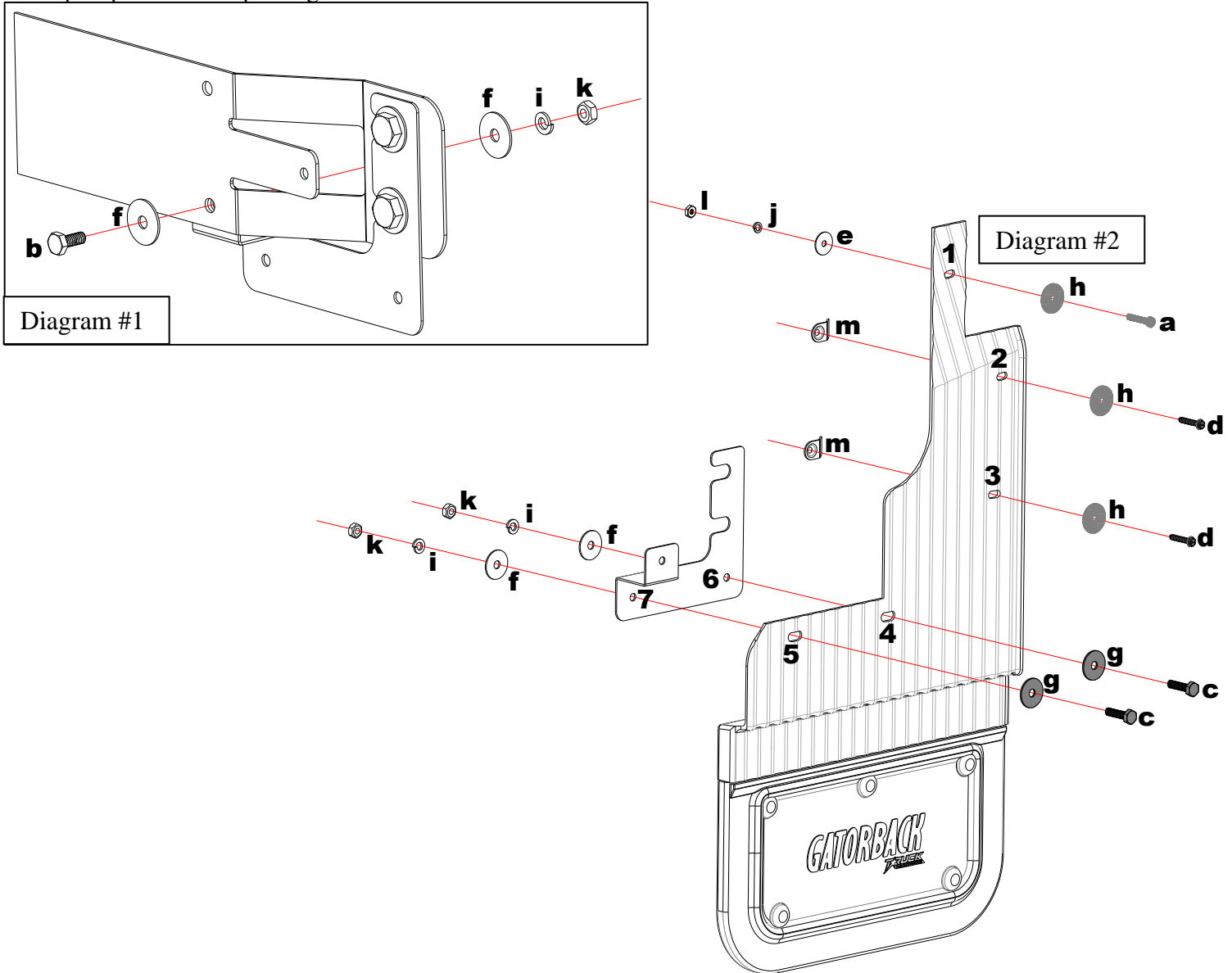

Please check out our YouTube channel to see an install video for this application

