



GATORBACK MUDFLAPS

Universal Nylon Offset Mud Flap Mounting Diagram & Instructions GN100 Series Dually

IMPORTANT:

The manufacturer is not responsible for negligent use of vehicle with mud flaps installed, including over-tightening of screws and bolts causing damage to vehicle or mud flaps.

Additionally, due the variances of lifts, tires, wheels, and offsets, it is the owners responsibility to determine if this is the correct mud flap for their application.

TOOLS REQUIRED:

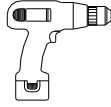

Electric or Re-Chargeable
1/2" or 3/8" Drill



3/8" Socket Driver

PARTS ENCLOSED: Parts Bag #770319 (Hardware) & #767491 (Caps)

(16) Tek Screw, SS, Blk Ox
1/4"-14 x 1-1/4" HWH
Part #010050

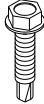

(16) Flat Washer
0.281" x 1.5" SS, Blk Ox.
Part #018087

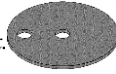

(2) Nylon Cap
Driver Side
Part #080642
Assembled on Upper Mount

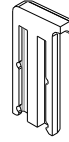

(2) Nylon Cap
Passenger Side
Part #080643
Assembled on Upper Mount

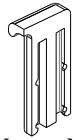

(2) Upper Mount
Universal, Dually
Part # 080681

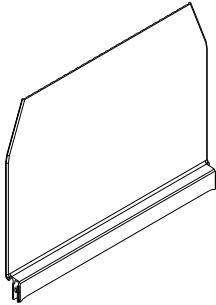

(2) Mud Flaps, Universal

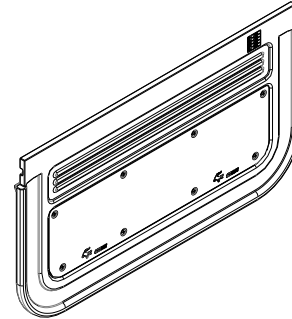

ASSEMBLY OF NYLON MUD FLAPS:

1. Remove locking caps from nylon upper mounts and set aside for reinstallation.
2. Remove and discard the plastic strip inside the track at the bottom of the nylon upper mount.
3. Slide rubber guide into track of nylon upper mount.
4. Reinstall locking cap(s) on bottom of nylon upper mount.
Note: To fully lock this cap into place, you should hear two clicks. When the cap is fully locked, it will be even with the offset part of the upper mount.
5. Repeat Procedure for second mud flap.

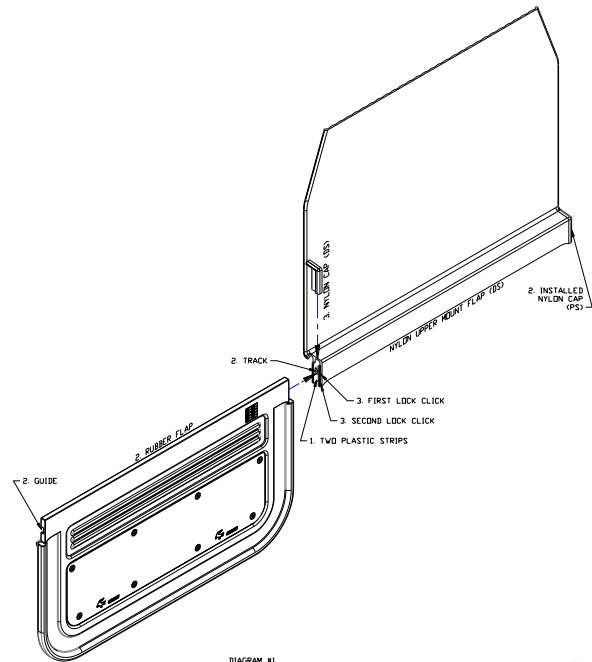

INSTALLATION

For ease of installation, it is suggested that the wheel be removed.

1. Before you install your Mud Flap Set, see the diagram and parts list for all necessary parts. Start on the Driver's side.
 2. Tuck the offset mud flap flange underneath the bottom of the wheel well and centered to the tire.
 3. Square the flap with the tire while putting pressure against the wheel well and mark the center line of the wheel well on the tire side of the mud flap.
 4. Now fasten the flap with eight washers and eight tek screws along the wheel well and wheel tub where there is metal lining behind the liner.
 5. Repeat procedure for the passenger side. Ensure all fasteners are tight.
- ✓ Check all fasteners for tightness. Repeat procedure on the passenger side.

