



Mud Flap Set

Universal, 12", 1.5" Offset

Mounting Diagram & Instructions

Black Anodized #GAA756618

(769620)

IMPORTANT:

The manufacturer is not responsible for negligent use of vehicle with mud flaps installed, including over-tightening of screws and bolts causing damage to vehicle or mud flaps.

TOOLS REQUIRED:

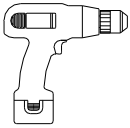

Electric or re-chargeable
1/2" or 3/8" drill.



1/4" Drill bit



3/8" Socket Driver

KIT CONTAINS:

(1) Mud Flap Assembly, DS
Part #769631

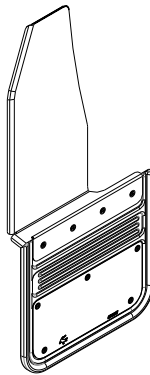

(1) Mud Flap Assembly, PS
Part #769632

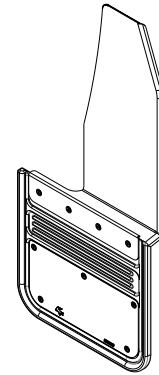

PARTS BAG #769637

a) (8) Tek Screw,
1/4" x 1-1/4", SS Blk Ox
Part #010050

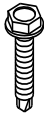

b) (8) Washer, SS Blk Ox
0.281 x 1" OD
Part #018069

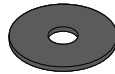

c) (8) Washer, Nylon
0.281" x 1"
Part #054085

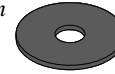

INSTRUCTIONS:

1. Before you install your upper mounts, see the Diagram #1 and parts list for all necessary parts. Start on the Driver's Side.
2. Square the flap with the tire while holding the flap up against the wheel well and the offset flange tuck underneath the wheel well. (See Diagram #1)
3. Locate the center of the wheel well or wheel flare on the back side of the stainless steel panel and drill four 1/4" holes from 'A' to 'D' on the stainless steel panel only.

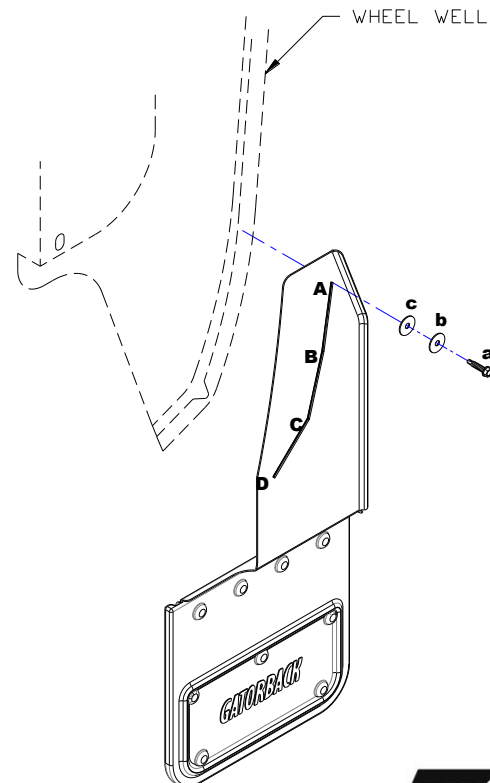

Note: Drill with caution, do not drill through the wheel well or wheel flare.

5. Secure the flap with four nylon washers four flat washers and four tek screws on hole 'A' to 'D'.
6. Repeat procedure for the passenger side.