

KIT INCLUDES:

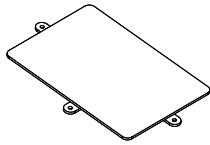

(1) Access Door
Part#702302

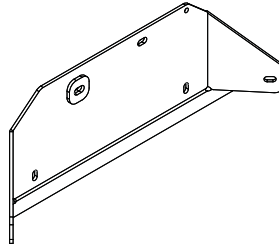

(1) Front Mount
Part #702515

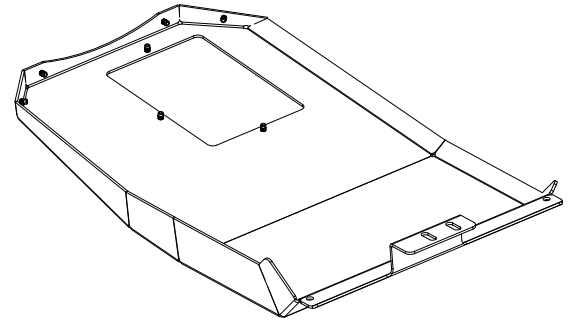

(1) Skid Plate
Part #702509

TOOLS:



Push Pin Pry Tool

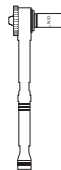

13/16" Socket Wrench

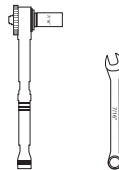

7/16" Open Wrench
or Socket Wrench

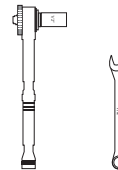

1/2" Open Wrench
or Socket Wrench

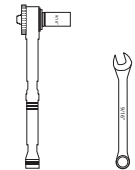

9/16" Open Wrench
or Socket Wrench

PARTS BAG: #702507

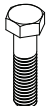

a) (1) Capscrew, Pltd
3/8" - 16x1.5"
Part #014012



b) (7) Cap Screw, SS
1/4" - 20x1"
Part #014007

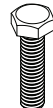

c) (1) Cap Screw, Pltd
5/16" - 18x1.5"
Part #014089

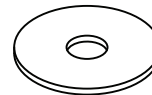

d) (7) Washer, Flat
0.281"x1"
Part #018028

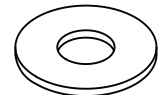

e) (2) Washer, Flat 3/8"x1"
Part #018046

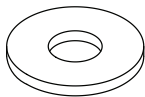

f) (2) Washer, Flat - 5/16"x1"
Part #018047



g) (7) Washer, Lock - 1/4"
Part #024000



h) (1) Washer, Lock - 5/16"
Part #024002



i) (1) Washer, Lock - 3/8"
Part #024006



j) (1) Nut, Hex - 3/8"
Part #025015



k) (1) Nut, Hex - 5/16"
Part #025028

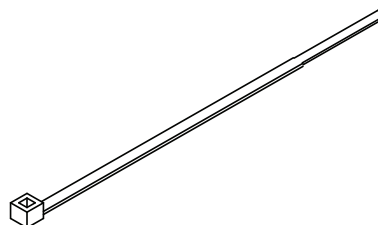

l) (1) Zip Tie - 4"
Part #054011

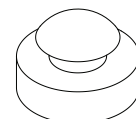

m) (2) Grommet, Button Type - 3/16"
Part #080647

INSTALLATION INSTRUCTIONS

1. Remove the factory hose/line push pin from the front cross member and tuck it aside so it does not impede the installation process. This will be secured later.

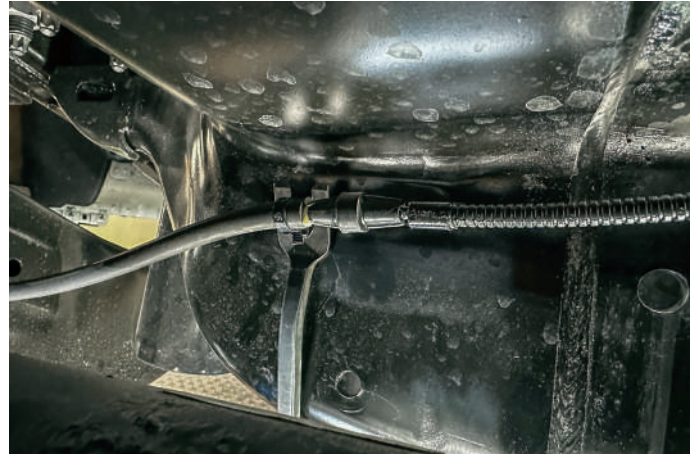
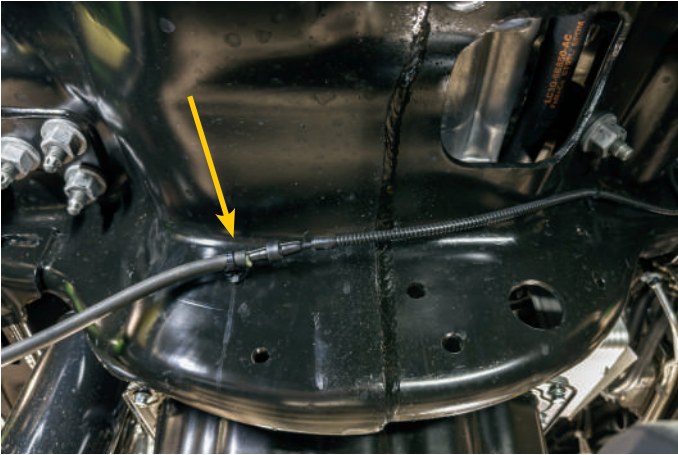

2. Start by loosely installing front mount to the crossmember.



3. Loosely install the driver side hole of the front mount to the cross member using a 3/8" capscrew (a) and flat washer (e) and secure using flat washer (e), lock washer (i) and hex nut (j).

4. Install the passenger side loosely the same way but using 5/16" capscrew (c), flat washer (f) and secure with flat washer (f) lock washer (h) and hex nut (k).

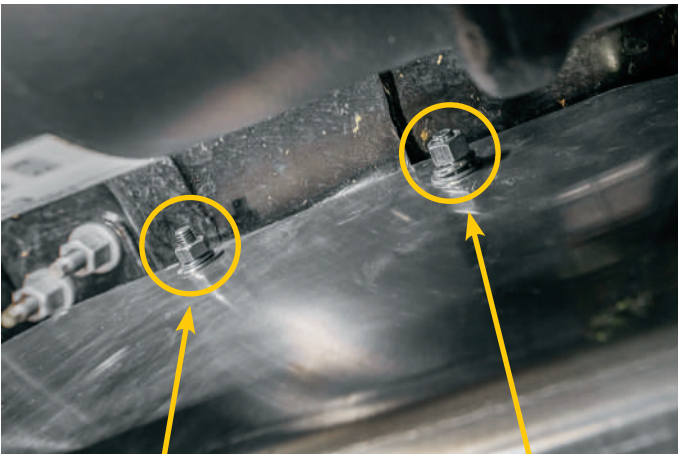

Passenger side 5/16"

Driver side 3/8"

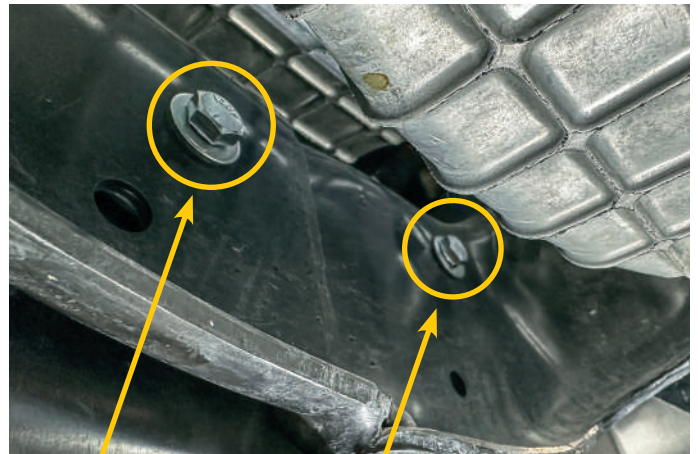

Driver side 3/8"

Passenger side 5/16"

5. Use a 21mm socket or 1/2" impact/ratchet to remove the two factory nuts from the transmission mount cross member.
Set these aside for later reinstallation.

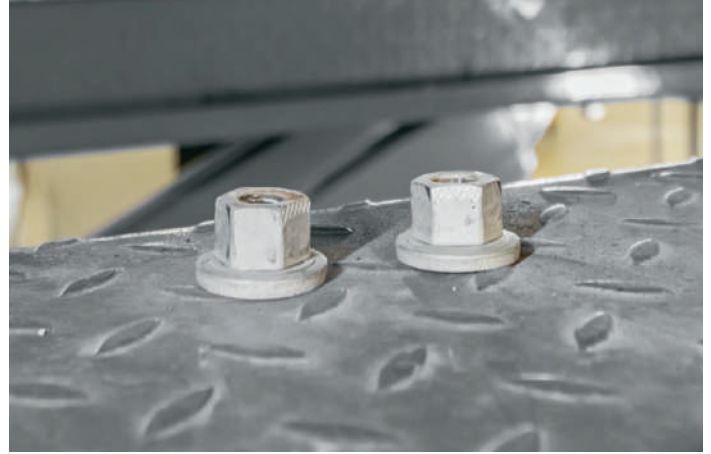

6. Insert grommets (m) in each hole at the back of the skid plate.



7. Slide the front of the skid plate into the front mount so the skid plate is supported by the front mount.



8. Once the front of the skid plate is supported by the front mount, hold the rear of the skid plate in place over the factory bolts in the transmission mount cross member and reinstall the factory nuts removed in step 5.



9. Now that the rear is secured, line up the clinch nuts in the front of the skid plate with the holes in the front mount. Secure using capscrew (b), lock washer (g) and flat washer (d).

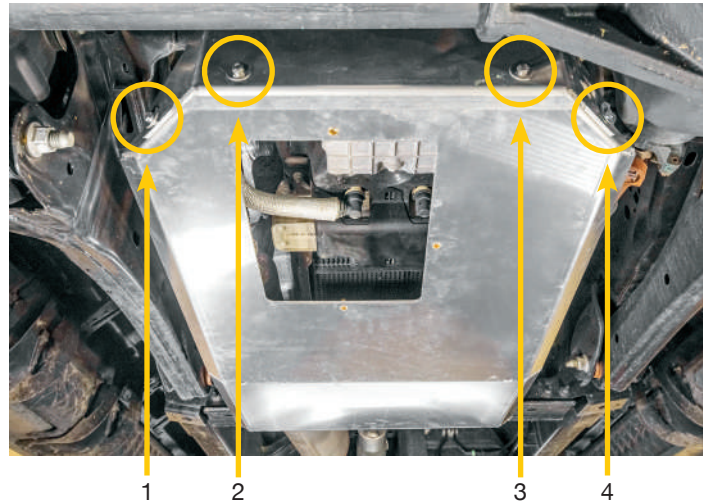

10. Install the access door to the clinch nuts on the skid plate using capscrew (b), lock washer (g) and flat washer (d).

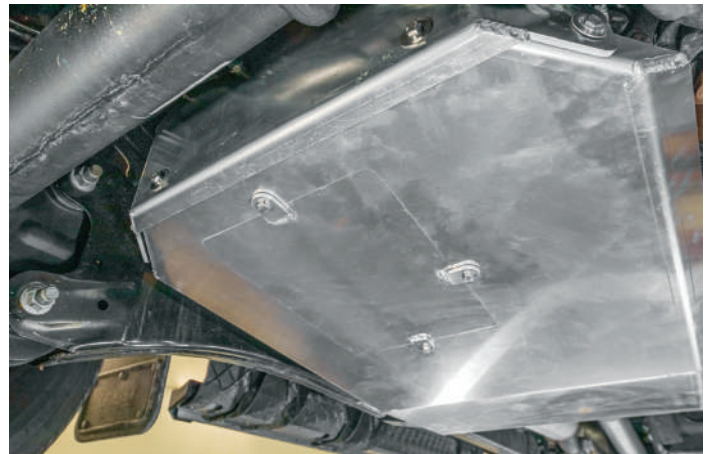

11. Using the zip tie (I), attach the factory hose line, removed from step 1, to the top passenger side hole in the front mount to ensure it is secured and safely out of the way.



12. Now that everything is in place, tighten all fasteners.



Front View

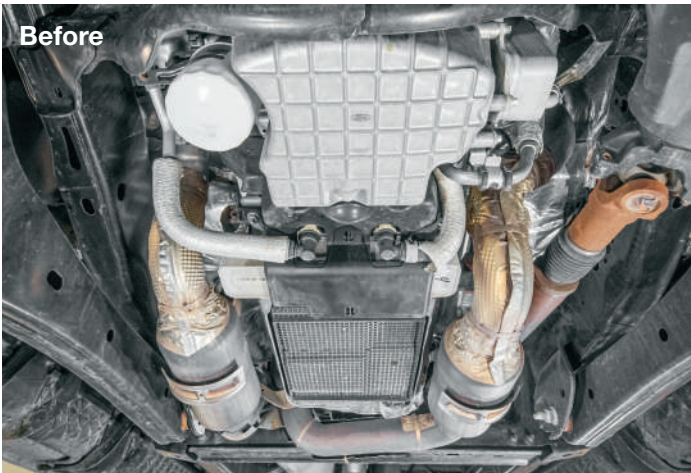

Rear View



Check out our YouTube channel for install video

www.truckhardware.ca

